

Consumer catalogue

WATER & GARDEN
2024/2025

LIVING WATER

Oase



It's all there!

OUR PRODUCT RANGE LEAVES NOTHING TO BE DESIRED

What does your dream water garden look like? Do you want a bubbling water feature or a gently rushing stream? Do you dream of a lively garden pond, a natural swimming pool or even a captivating koi pond? Whatever it is: OASE helps you find the right technology, while also giving you plenty of ideas, knowledge and experience.

Our new user catalogue presents the OASE product range full of solutions, suggestions, tips and tricks, helping you to design your water garden project exactly how you want it, down to the last detail. You will see: The possibilities are almost endless.

It does not matter whether you are a beginner or a true pond professional. In addition to our specialist retail experts, the many examples, recommendations and project descriptions featured on our website offer inspiring and informative support. Experience the exceptional efficiency and smart controllability of our products for yourself.



I hope you enjoy discovering the product world of OASE. Let your imagination run wild!

Yours,
Thorsten Muck
Chief Executive Officer



THE PURE JOY OF THE WATER GARDEN

Perfect: Inspirations for your project

A garden with water does not have to be created overnight. Start with a Level 1 project and gradually add more highlights to suit your own taste. Our huge selection of OASE individual products and sets makes it easy for you to create your dream water garden with little effort. It's easy enough that anyone can develop a knack for pond building.

Mini ponds and raised ponds

A pond is the centrepiece of every water garden. No matter what size it is. Mini ponds can be created using preformed ponds in just a few steps and with little prior knowledge. Even a small pond with a volume of 80 litres produces a great effect. Indeed, a self-built raised pond on a balcony can provide a peaceful place to mediate and relax.

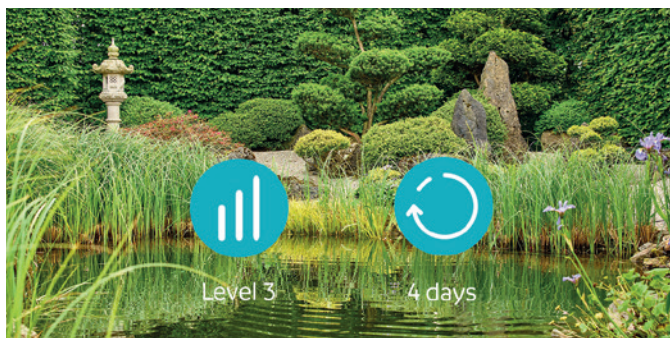
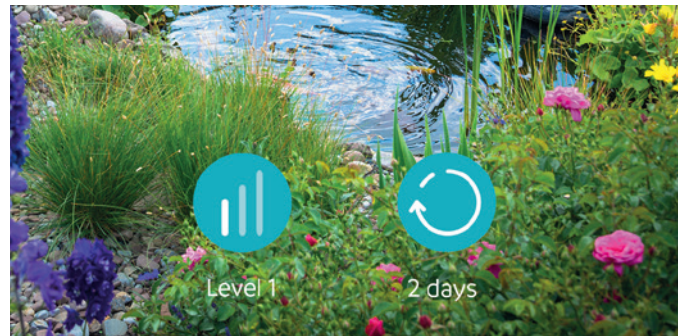

Ponds with pond liners

Do you want to determine the shape, size and style of your pond yourself? With pond liners, you take every aspect of the design into your own hands. If you want a pond larger than 2500 litres, they are always the better alternative to preformed ponds and offer a unique habitat for fish and more. This Level 3 project can be implemented by experienced tradespeople and DIY-ers. Alternatively, call in the professionals.

Waterfalls for your garden

If you want something that both looks and sounds unique, waterfalls are hard to beat. They are particularly exciting as part of a specially constructed wall, which can be built in your favourite place to sit and relax. Sounds complex? It doesn't have to be. All you need is inspiration for the design, a little DIY talent and a few helping hands.

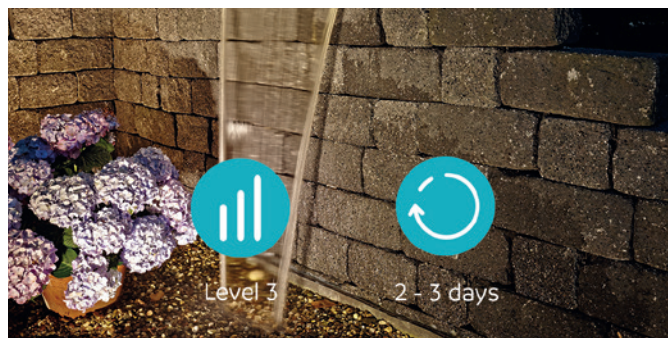

Streams in the water garden

The babbling of a clear, small stream is one of the most beautiful sounds in nature. With modular watercourse elements this fascinating spectacle can be integrated anywhere. Whether with or without a pond, small or large – you need surprisingly little time for this project.

Freely designed watercourse

A freely designed watercourse gives you the opportunity to express yourself individually. Architectural, natural or Japanese style – everything is possible.

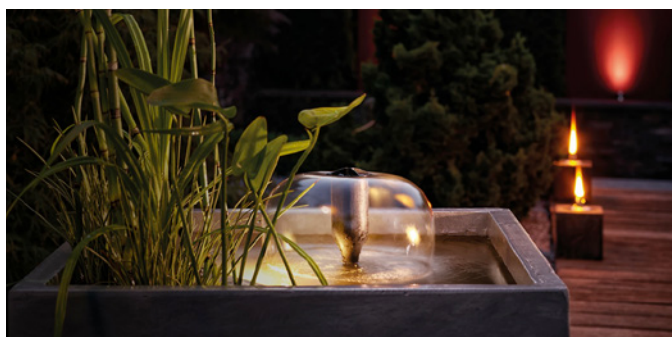
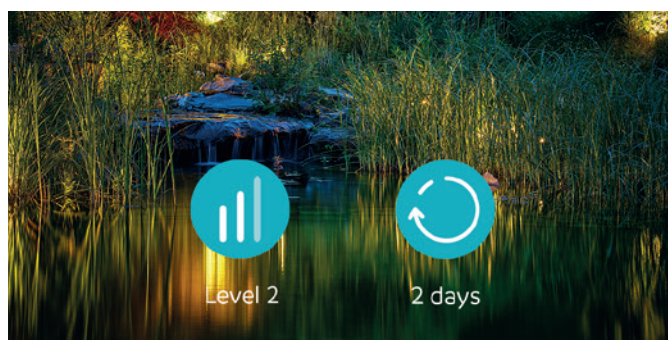

Water features and fountains

Do you have a small garden, want to spruce up your terrace or add a water element to your balcony? Water features and floating fountains give your water garden a third dimension. You can easily design your own small water fountain, even with limited materials and minimal space.



DISCOVER MORE!

Further information and valuable expert tips for numerous project ideas can be found online at www.oase.com/en/lifestyle/diy.html and via the adjacent QR code.



Emotional developers

At OASE, developing and manufacturing first-class products is the means to the true end: staging underwater living spaces and touching, moving and inspiring our customers. To this end, our specialists work together across different departments to find the best solution – with expertise, creativity and passion. The result? Energy-efficient innovations and top-quality, smart solutions.

We regularly analyse our solutions in our own test laboratory. We make no room for compromises, ensuring we stick to the OASE quality promise.

Our passion for innovative products has already received several awards. For the third time in a row, we were voted one of the TOP 100 innovators in Germany. More information at: www.oase.com/en/topinnovator



Make living spaces efficient

High energy efficiency and maximum design freedom

Smart energy-saving products for your garden



Using our vast range, you can transform your garden into a place of wellbeing. At the same time, permanently reduce ongoing energy costs: This is safe and easy with our smart control functions and energy-efficient pond pump models. Discover energy-saving product examples and clever savings potentials in our overview.

www.oase.com/en/saving-energy



Powerful and economical: The AquaMax Eco product ranges

Thanks to the economical motor, these pond pumps work particularly efficiently even under full power. You can easily balance the energy consumption via the app. In the Eco Classic C models, the controller required for this is directly integrated. Our models with the unique Seasonal Flow Control (SFC) function even more effectively: The filter and gravity-fed pumps of the Eco Premium (from model 12000), Eco Expert and Eco Titanium series independently reduce their water volume and delivery head by around 50 percent at two temperature levels, below approx. 17°C and once again below approx. 10°C. This saves up to 30 percent of energy costs annually.



Efficiently controlled: The Bitron Eco

Due to its longer service life, the effective UVC pre-clarifier saves on lighting costs in particular. In addition, it only switches on when it is really needed. This reduces energy costs by up to 50 percent without comprising on cleaning performance. If you use the Bitron Eco with 75 percent power all year round, you can save up to around 527 kW/h.

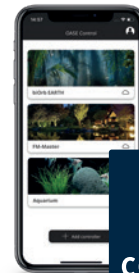

Save smart: The OASE Control app

The smart pumps, filters and lighting in your garden can be configured safely and conveniently at any time with the OASE Control app. This makes it the perfect assistant for reducing energy costs. For example, you can adjust the performance of the pumps or automatically set your lighting times shorter.



CORE 6 Technology



NEXT LEVEL EFFICIENCY



Efficiency, energy savings, sustainability, convenience – the new OASE CORE 6 Technology combines everything into one cohesive, complete system. This motor technology, which is new to ponds and irrigation, is taking us to the next level, especially in terms of energy efficiency.

This is because CORE 6 Technology enables an optimised current flow, ensuring that the rotor in the pump core operates not only powerfully, but also more smoothly, more quietly and therefore more efficiently. Thanks to its powerful performance, combined with OASE's usual high standard of quality, the pump also attains the next level of longevity.

The next generation of the AquaMax Eco Premium series is the first to be fitted with this new OASE standard. Equipped with CORE 6 Technology, the pumps run more quietly, more efficiently, more effectively and for longer.

Voice control

Voice control via the OASE Control app

The OASE Control app allows all connected products in the OASE world to be managed centrally. Now, you can also control the FM-Master Cloud sockets and the OASE Control-enabled pumps using voice control (Alexa or Google Home). This makes it even more convenient to manage your digitally controlled garden and aquarium world from a sun lounger or sofa. You can also add these devices to existing SmartHome groups and applications.

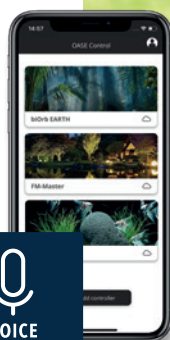

Contents

- 12** Water features & water pumps
 - 12** WATER FEATURES
 - 16** WATER FEATURE PUMPS

- 22** Filter, watercourse and swimming pond pumps
 - 24** AQUAMAX

- 30** Filters, UVC clarifiers & aerators
 - 32** FILTERS COMPARED
 - 36** UNDERWATER FILTERS
 - 37** PRESSURE FILTERS
 - 39** FLOW-THROUGH FILTERS
 - 42** DRUM FILTERS

 - 52** UVC CLARIFIERS
 - 56** AERATOR
 - 58** ICE PREVENTER

- 60** Cleaning & skimmers
 - 62** SURFACE SKIMMER
 - 64** POND VACUUMS & POOL VACUUMS
 - 67** POND CARE

- 68** Food
 - 71** DEVELOPMENT FOOD
 - 72** STANDARD FOOD
 - 73** MIXED FISH STOCK
 - 75** KOI FOOD

- 76** Care products & fish medicine
 - 78** AQUAACTIV CARE PRODUCTS
 - 86** AQUAACTIV FISH MEDICINE

- 88** Lighting & power
 - 90** LIGHTING CONCEPT
 - 92** OASE CONTROL
 - 94** LUNAQUA CONNECT

 - 102** LED SPOTLIGHTS

 - 107** GARDEN CONTROL SYSTEMS

- 110** Pond construction
 - 112** POND PLANNING & IMPLEMENTATION
 - 115** FLEECES & LINERS
 - 116** PRE-FORMED PONDS
 - 118** ACCESSORIES FOR POND PLANTING
 - 120** POND EDGE SYSTEM & BED EDGING
 - 121** WATERCOURSE ELEMENTS
 - 122** WATERFALLS
 - 124** DECORATIVE ROCK-LIKE COVERS
 - 125** WATER RESERVOIR

- 126** Good to know
 - 128** ENERGY EFFICIENCY CLASSES
 - 129** WATERCOURSE DIAGRAMS
 - 130** FRICTION LOSSES
 - 130** PRO PRODUCTS
 - 131** OASE GUARANTEE

12



22



30



60



88

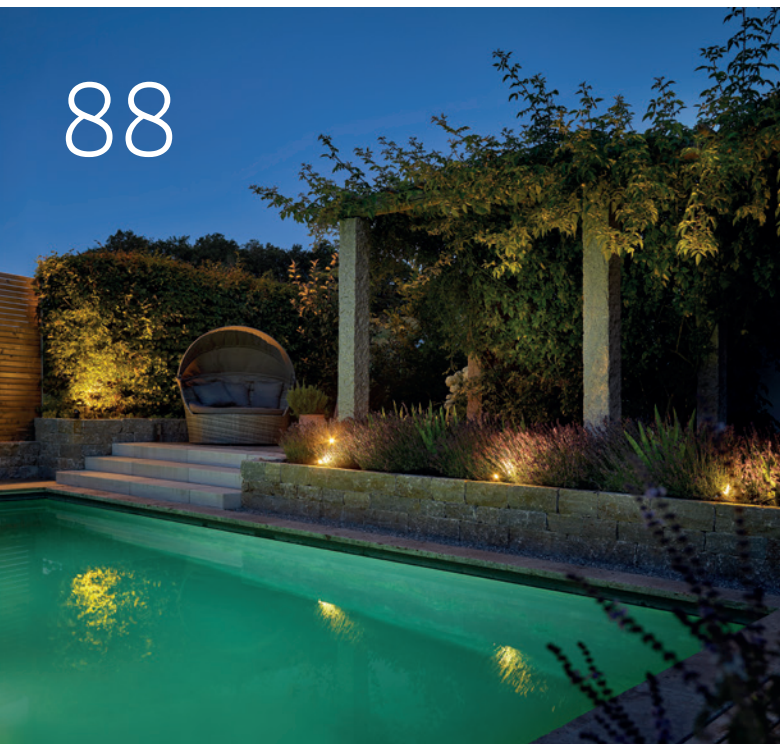

110





Water features and water feature pumps



Further information
is available at:
[www.oase.com/en/
watercourse-pumps](http://www.oase.com/en/watercourse-pumps)

14 Water features

14 **WATER STARLET/WATER
TRIO/WATER QUINTET**

15 **WATERJET LIGHTNING**

16 Water feature pumps

16 **AQUARIUS FOUNTAIN SET CLASSIC**

17 **AQUARIUS FOUNTAIN SET ECO**

18 **AQUARIUS UNIVERSAL CLASSIC**

19 **AQUARIUS UNIVERSAL PREMIUM**

20 **AQUARIUS ECO EXPERT**

RADIANT FOUNTAINS FOR MODERN GARDEN DESIGNS

Water Starlet/Trio/Quintet



Water Starlet complete package

- The scope of delivery includes five pumps and light rings, each with six warm white LEDs, a cable and a transformer
- Protected LEDrings:** Ensures that the water jets are illuminated constantly
- Varied water patterns:** Fixed programming ensures fascinating water patterns
- Two options:** Floating or standing on the ground
- Plug 'n' spray:** Quick and easy installation
- Less maintenance:** Constant maintenance is a thing of the past
- Nicer splashing:** Can also be used in swimming ponds
- Compact:** Floating water feature with five fountain nozzles

Water Trio/Quintet complete package

- Everything included: three/five pumps, three/five nozzles, transformer, cables, external controller with remote control
- High-quality enjoyment:** Water feature fountains illuminated with warm-white LEDs
- Safety first:** Durable base plate protects against damage
- Full flexibility:** The mounting surface can be selected freely
- Fascinating fountains:** Fountain heights (30–140 cm) and light intensities are pre-programmed and ready to go
- Ample freedom:** Control the programs from up to 80 m away simply via remote control
- Sustainable:** Low energy consumption
- Maintenance:** It couldn't be simpler

ACCESSORIES

WATER RESERVOIR WR 100

The weather-resistant solution for flexible installation.

Item no. 37112 (page 117)



EXTRAS

RECOMMENDATION

Spray water can be minimised by selecting a pond with a diameter of at least 3 m. The OASE water reservoir WR 100 can be extended with a pond liner, for example.



PRODUCT	WATER STARLET	WATER TRIO	WATER QUINTET
Dimensions (L x W x H)	330 x 270 x 135 mm	430 x 300 x 240 mm	
Guarantee (+ request guarantee) ¹⁾	2 years	2 + 1 years	2 + 1 years
luminous colour	Warm white	Warm white	Warm white
Jet diameter	4 mm	5 mm	5 mm
Cable length for 12 V device	2.50 (power supply unit) + 8.00 m		
Max. fountain height	0.70 m	1.40 m	1.40 m
12 V control box			
Controller dimensions (L x W x H)	215 x 180 x 305 mm		
Power consumption	26 W	40 W	50 W
Primary rated voltage (control unit)	12 V/DC	12 V/DC	12 V/DC
Max. hand transmitter/radio range	-	80 m	80 m
Power supply			
Power supply unit dimensions (L x W x H)	100 x 55 x 70 mm	160 x 100 x 100 mm	
Rated voltage (primary, secondary)	230 V/50 Hz, 12 V/AC		
Item no. (GB Version)	Not available in GB		
Item no.	50214	50240	50187

COLOURED WATER JETS – EVEN FOR SMALL AREAS OF WATER

WaterJet Lightning



- **Complete package:** Water Jet Lightning double set, pump (1500 l/h, 17 W), transformer, cable, external control system – everything you need in one set
- **Plug 'n' spray:** Quick and easy installation
- **Maintenance:** It couldn't be simpler
- **Fantastic colour:** Easily set your favourite colour
- **Free selection:** Programme selection from a distance of up to 80 m is possible via remote control
- **Jet stream:** The angles of the waterjets can be individually adjustable
- **Elegant and safe:** The high-quality stainless steel base can be screwed on, depending on the mounting surface
- **Sustainable:** Low energy consumption
- **To the minute:** Can be combined with a timer (not included)
- **Full program:** Four fixed programs with exciting combinations of multiple jet widths and RGB colours

EXTRAS

RECOMMENDATION

Enjoy the many different colours of the luminous water jets at dusk. They are shown to their best advantage in the evening light. To ensure that the water arcs retain their perfect shape, the installation should take place in a location that is protected from the wind. For perfect enjoyment ensure good water quality.



PRODUCT	WATERJET LIGHTNING
Dimensions (L x W x H)	150 x 115 x 200 mm
Guarantee (+ request guarantee) ^{*p-131}	2 + 1 years
Cable length for 12 V device (with power supply unit)	2.50 (power supply unit) + 8.00 m
Max. parabolic height	0.90 m
Max. parabolic width	1.80 m
Jet diameter	8 mm
12 V control box	
Controller dimensions (L x W x H)	215 x 180 x 305 mm
Power consumption	41 W
Primary rated voltage (control unit)	12 V/DC
Max. hand transmitter/radio range	80 m
Power supply	
Power supply unit dimensions (L x W x H)	160 x 100 x 100 mm
Rated voltage (primary, secondary)	220–240 V / 50–60 Hz, 12 V/DC
Item no. (GB Version)	Not available in GB
Item no.	50191

Aquarius Fountain Set Classic



- **Height-adjustable:** Position the water fountain as desired using the telescopic tube extension (including integrated swivel head)
- **Stable footing:** The supporting feet make it easy to position on the bottom of any pond
- **More water fun:** With a second, adjustable outlet for further features – from water spouts to mini watercourses
- **Now even better:** Energy consumption is reduced by up to 40% in comparison to previous models – yet it still boasts a higher water pressure and a higher flow rate
- **Adjustable:** Adjust the height of the fountain mechanically as desired
- **Included:** Three fountain attachments and a telescopic pipe extension with an integrated swivel head for a variety of water patterns
- **Clever design:** Optimised nozzle holder for precise, even water patterns
- **Thermal protection:** This feature ensures that the device is thermally protected

	1 VULCAN		2 LAVA		3 MAGMA	
	Ø cm	H cm	Ø cm	H cm	Radius/cm	H cm
Set 750	45	70	20	–	60	70
Set 1000	70	75	35	–	70	80
Set 2000 E	120	155	65	–	120	155
Set 3000 E	160	195	75	–	150	190
Set 4000 E	180	220	80	–	180	220

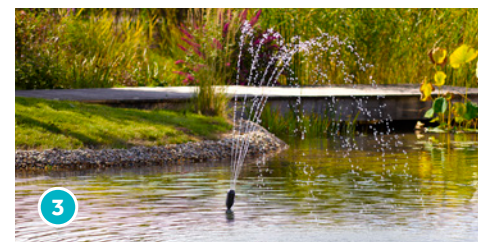
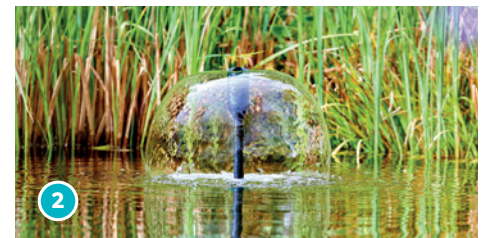

1. Vulcan nozzle 2. Lava nozzle 3. Magma nozzle

PRODUCT	AQUARIUS FOUNTAIN SET CLASSIC 750	AQUARIUS FOUNTAIN SET CLASSIC 1000	AQUARIUS FOUNTAIN SET CLASSIC 2000 E	AQUARIUS FOUNTAIN SET CLASSIC 3000 E	AQUARIUS FOUNTAIN SET CLASSIC 4000 E
Dimensions (L x W x H)	180 x 205 x 140 mm	180 x 205 x 140 mm	180 x 205 x 140 mm	180 x 205 x 140 mm	180 x 205 x 140 mm
Rated voltage	220–240 V/50 Hz	220–240 V/50 Hz	220–240 V/50 Hz	220–240 V/50 Hz	220–240 V/50 Hz
Power consumption	9 W	11 W	18 W	26 W	42 W
Guarantee (+ request guarantee) ^{*)p.131}	2 + 1 years	2 + 1 years	2 + 1 years	2 + 1 years	2 + 1 years
Max. flow rate (litres per hour)	720 l/h	1000 l/h	2100 l/h	3000 l/h	4000 l/h
Max. head height, metres	1.10 m	1.30 m	2.10 m	2.50 m	2.90 m
Outlet connections	13/19/25 mm (½", ¾", 1")	13/19/25 mm (½", ¾", 1")	13/19/25 mm (½", ¾", 1")	13/19/25 mm (½", ¾", 1")	13/19/25 mm (½", ¾", 1")
Item no. (GB Version)	43042	57438	77375	77376	77377
Item no.	43041	57399	77371	77372	77374

POWERFUL FOUNTAIN PUMPS WITH ENERGY-SAVING DRIVE

Aquarius Fountain Set Eco



- **All-in-one:** Fountain pump sets, powerful yet energy-efficient
- **Height-adjustable:** Position the water fountain as desired using the telescopic tube extension (including integrated swivel joint)
- **Super clean:** The adapter with a stainless-steel fine filter sieve ensures that water patterns remain consistent – even as dirt sets in
- **Safe and sound:** The wide base ensures high stability
- **Included in the package:** Lava and Vulcan nozzles are included in the scope of delivery
- **More water fun:** Connect additional features to the second, adjustable outlet – from filters to water spouts
- **Environmental Function Control:** This is EFC, by OASE: no problems caused by the pump being blocked or running dry

	1 VULCAN		2 LAVA	
	Ø cm	H cm	Ø cm	H cm
Set 5500	155	220	90	–
Set 7500	240	275	90	–
Set 9500	275	335	90	–



1. Vulcan nozzle 2. Lava nozzle

PRODUCT	AQUARIUS FOUNTAIN SET ECO 5500	AQUARIUS FOUNTAIN SET ECO 7500	AQUARIUS FOUNTAIN SET ECO 9500
Dimensions (L x W x H)	290 x 230 x 180 mm	290 x 230 x 180 mm	290 x 230 x 180 mm
Rated voltage	220–240 V/50 Hz	220–240 V/50 Hz	220–240 V/50 Hz
Power consumption	70 W	85 W	125 W
Guarantee (+ request guarantee) ^{pp.131}	3 + 2 years	3 + 2 years	3 + 2 years
Max. flow rate (litres per hour)	5500 l/h	7500 l/h	9500 l/h
Max. head height, metres	3.80 m	4.00 m	5.20 m
Outlet connections	19/25/32/38 mm (¾", 1", 1 ¼", 1 ½")	19/25/32/38 mm (¾", 1", 1 ¼", 1 ½")	19/25/32/38 mm (¾", 1", 1 ¼", 1 ½")
Item no. (GB Version)	41924	41926	41928
Item no.	41923	41925	41927



Aquarius Universal Classic



- **Pure lifestyle:** Can be enjoyed indoors or outdoors (440i only indoors)
- **High suction:** The pump conveys the water even when the water level is low
- **A feast for your ears:** Nothing but the sound of water splashing thanks to the extreme smoothness of operation
- **Flow rate:** Mechanically regulate the water flow rate quickly and easily
- **Well thought out:** Complete product series, with thermal protection
- **Universal:** From the Classic 600, installation can be either submerged or in dry conditions
- **New:** 1000 and 2000 series models are also available in the 12 V version



Examples of use: Aquarius Universal is ideal for small spring stones, statue and decorative fountains.



Aquarius Universal: For statue and decorative fountains, because even shallow water is optimally sucked in.

EXTRAS

RECOMMENDATION

For an attractive spring stone water pattern, the best way to choose a pump is to calculate 0.5–1 l/min water per cm of stone diameter.

Your OASE dealer will be happy to advise you.

PRODUCT	AQUARIUS UNIVERSAL CLASSIC 440I	AQUARIUS UNIVERSAL CLASSIC 440	AQUARIUS UNIVERSAL CLASSIC 600	AQUARIUS UNIVERSAL CLASSIC 1000	AQUARIUS UNIVERSAL CLASSIC 1500	AQUARIUS UNIVERSAL CLASSIC 2000	AQUARIUS UNIVERSAL CLASSIC 3000	
Dimensions (L x W x H)	50 x 55 x 55 mm	50 x 55 x 55 mm	100 x 55 x 62 mm	125 x 80 x 75 mm	125 x 80 x 75 mm	125 x 80 x 75 mm	245 x 130 x 135mm	
Rated voltage	230 V / 50 Hz	230 V / 50 Hz	230 V / 50 Hz	230 V / 50 Hz	230 V / 50 Hz	230 V / 50 Hz	230–240 V/50 Hz	
Power consumption	5 W	5 W	7 W	15 W	18 W	25 W	40 W	
Power cable length	1.50 m	10.00 m	10.00 m	10.00 m	10.00 m	10.00 m	10.00 m	
Guarantee (+ request guarantee) ^{*)}	2 years	2 years	3 + 2 years	3 + 2 years	3 + 2 years	3 + 2 years	3 + 2 years	
Max. flow rate (litres per hour)	440 l/h	440 l/h	600 l/h	1000 l/h	1500 l/h	2000 l/h	3000 l/h	
Max. head height, metres	0.75 m	0.75 m	1.20 m	1.50 m	1.80 m	2.00 m	3.20 m	
Hose connection	13 mm (½")	13 mm (½")	13/19/25 mm (½", ¾", 1")				19/25/32/38 mm (¾", 1", 1 ¼", 1 ½")	
Setup type	For submerged use only		Can be set up underwater & dry installed					
Item no. (GB Version)	Not available in GB	36746	36977	36980	36983	36978	90222	
Item no.	36673	36726	36975	36950	36951	36953	90221	

POWER PACKS FOR LARGE AND IMPRESSIVE DECORATIVE FOUNTAINS

Aquarius Universal Premium



- **High suction:** The pump conveys the water even when the water level is low
- **Flow rate:** Mechanically regulate the water flow rate quickly and easily
- **Sustainable:** Low power consumption
- **Safety:** Integrated thermal protection
- **A feast for your ears:** Nothing but the sound of water splashing thanks to the extreme smoothness of operation
- **Stable:** Removable stand, for mounting even in confined spaces
- **Winter-proof:** this pump is damage resistant down to temperatures as low as -20°C



Examples of use: Aquarius Universal is ideal for operating modern waterfalls.

EXTRAS

RECOMMENDATION

You can use the OASE fountain attachments to create different water patterns that suit your taste. Combined with the appropriate optional OASE Illumination, these can be perfectly staged.

The special AquaActiv PumpClean cleaner extends the service life of your water feature pump and ensures lasting high performance.

PRODUCT	AQUARIUS UNIVERSAL PREMIUM ECO 3000	AQUARIUS UNIVERSAL PREMIUM ECO 4000	AQUARIUS UNIVERSAL PREMIUM 4000	AQUARIUS UNIVERSAL PREMIUM 5000	AQUARIUS UNIVERSAL PREMIUM 6000	AQUARIUS UNIVERSAL PREMIUM 9000	AQUARIUS UNIVERSAL PREMIUM 12000
Dimensions (L x W x H)	245 x 130 x 135 mm		315 x 140 x 130 mm		340 x 160 x 160 mm		
Rated voltage	220–240 V/50 Hz						
Power consumption	40 W	50 W	65 W	85 W	110 W	195 W	270 W
Guarantee (+ request guarantee) ^{*)-131}	3 + 2 years	3 + 2 years	3 + 2 years	3 + 2 years	3 + 2 years	3 + 2 years	3 + 2 years
Max. flow rate (litres per hour)	3000 l/h	4000 l/h	4000 l/h	5000 l/h	6000 l/h	9000 l/h	12,000 l/h
Max. head height, metres	3.20 m	3.40 m	3.40 m	4.50 m	5.00 m	6.00 m	7.00 m
Hose connection	19/25/32/38 mm (¾", 1", 1 ¼", 1 ½")					25/32/38 mm (1", 1 ¼", 1 ½")	
Electronic adjustment	No	No	Yes	Yes	Yes	Yes	Yes
Item no. (GB Version)	-	-	-	-	-	-	-
Item no.	57390	57392	56614	56617	56637	56876	56879

VARIABLE WATER PATTERNS – EVEN IN SWIMMING PONDS

Aquarius Eco Expert



- **Adapter set:** Connect G 1- and G 1 ½ nozzles
- **50% less:** This pump requires so much less energy than its predecessor model
- **Durable:** The robust housing, which also contains stainless steel, is super durable
- **Environmental Function Control:** This is EFC, by OASE: no problems caused by the pump being blocked or running dry
- **"Made in Germany":** Precise and reliable engineering skills at a particularly high level of quality
- **Versatile:** You can place this pump in dry conditions or submerge it in water
- **Change of scenery:** This is DFC, by OASE: different fountain heights can be controlled individually thanks to the innovative dynamic function
- **Network-enabled:** "Smart"-ready, energy-efficient pump generation – for an extremely powerful yet economic pump performance
- **Compatible with the app:** Simply download the OASE Control app (from the App Store or via GooglePlay) and you're ready to go

* **System requirements:** A Garden Controller Cloud or InScenio FM-Master Cloud is required to use the OASE Control functions.



Robust filter basket: This robust stainless-steel filter basket easily conveys coarse dirt particles up to 4 mm in size.

EXTRAS

RECOMMENDATION

You can use the OASE fountain attachments to create different water patterns that suit your taste. Combined with the appropriate optional OASE Illumination, these can be perfectly staged. For an attractive spring stone water pattern, the best way to choose a pump is to calculate 0.5–1 l water/min per cm of stone diameter.



Winter-proof: This pump is damage-resistant down to temperatures as low as -20°C.

AQUARIUS ECO EXPERT 20000/12 V

This electronic switching power supply was developed in-house and is perfectly designed for transforming an electricity supply from 230 V to 12 V for swimming ponds.





12 V pumps
for swimming
ponds and
bathing ponds

Fountain attachments: For harmonious water patterns.

PRODUCT	AQUARIUS ECO EXPERT 20000/12 V	AQUARIUS ECO EXPERT 22000	AQUARIUS ECO EXPERT 28000	AQUARIUS ECO EXPERT 36000	AQUARIUS ECO EXPERT 44000
Dimensions (L x W x H)	490 x 215 x 235 mm	490 x 215 x 235 mm	490 x 215 x 235 mm	540 x 225 x 250 mm	540 x 225 x 250 mm
Rated voltage	220–240 V / 50–60 Hz, 12 V/DC	220–240 V / 50/60 Hz	220–240 V / 50/60 Hz	220–240 V / 50/60 Hz	220–240 V / 50/60 Hz
Power consumption	30–240 W	350 W	440 W	550 W	700 W
Guarantee (+ request guarantee) ²⁰⁻¹³¹	3 + 2 years	3 + 2 years	3 + 2 years	3 + 2 years	3 + 2 years
Max. flow rate (litres per hour)	20,000 l/h	22,000 l/h	27,900 l/h	36,000 l/h	44,000 l/h
Max. head height, metres	6.60 m	9.60 m	10.00 m	10.20 m	10.50 m
Hose connection	38/50 mm (1 ½", 2")	38/50 mm (1 ½", 2")	38/50 mm (1 ½", 2")	38/50 mm (1 ½", 2")	38/50 mm (1 ½", 2")
Electronic adjustment	Yes	Yes	Yes	Yes	Yes
Item no. (GB Version)	Not available in GB	-	-	-	-
Item no.	78109	42405	42404	54612	54613



Filter, water- course and swimming pond pumps



Further information
is available at:
[www.oase.com/en/
pond-pumps](http://www.oase.com/en/pond-pumps)

22 Filter, watercourse and swimming pond pumps

- 24 **AQUAMAX ECO CLASSIC**
- 25 **AQUAMAX ECO CLASSIC C**
- 26 **AQUAMAX ECO PREMIUM**
- 27 **AQUAMAX ECO TWIN**
- 28 **AQUAMAX ECO EXPERT**
- 29 **AQUAMAX ECO TITANIUM**

Multiple pumps can be controlled
via the app:

Simply download the OASE Control app,
register and get started*



DOWNLOAD THE APP NOW

App Store



DOWNLOAD THE APP NOW

Google Play



* **System requirements:** A Garden Controller Cloud or InScenio FM-Master Cloud is required to use the OASE Control functions.

THE POWERFUL CLASSIC – NOW EVEN MORE EFFICIENT

AquaMax Eco Classic



- **Fully economical:** The energy-efficient motor of the AquaMax Eco Classic saves electricity – and therefore money
- **Up to 40 percent less:** The 2500 E and 3500 E require so much less energy than the predecessor model
- **Environmental Function Control:** This is EFC, by OASE: no problems caused by the pump being blocked or running dry
- **Dirt be gone:** Reliable removal of plant parts or fish faeces up to a size of 8 mm
- **Included:** A special hose adapter with threaded collar for different hose sizes (25/32/38 mm) is included in the scope of delivery
- **Swimming and natural ponds:** Possible to use in an external pump vault



Powerful and reliable
The AquaMax Eco Classic pumps pond water to the watercourse, waterfall or filter system.



Coarse debris removal: The large-surface wrap-around strainer allows coarse debris particles such as fish waste or dead plants up to 8 mm in size to pass through.



Energy efficient motor: The efficient OASE motor is particularly economical and effectively reduces running costs.

PRODUCT	AQUAMAX ECO CLASSIC 2500 E	AQUAMAX ECO CLASSIC 3500 E	AQUAMAX ECO CLASSIC 5500	AQUAMAX ECO CLASSIC 8500	AQUAMAX ECO CLASSIC 11500	AQUAMAX ECO CLASSIC 14500	AQUAMAX ECO CLASSIC 17500
Dimensions (L x W x H)	280 x 230 x 140 mm						
Rated voltage	220–240 V/50 Hz						
Power consumption	23 W	35 W	60 W	80 W	100 W	135 W	170 W
Guarantee (+ request guarantee) ^{7p-131}	3 + 2 years	3 + 2 years	3 + 2 years	3 + 2 years	3 + 2 years	3 + 2 years	3 + 2 years
Max. flow rate (litres per hour)	2600 l/h	3500 l/h	5300 l/h	8300 l/h	11,000 l/h	13,600 l/h	17,400 l/h
Max. head height, metres	2.20 m	2.60 m	2.80 m	3.20 m	3.30 m	3.40 m	3.70 m
Hose connection	25/32/38 mm (1", 1 ¼", 1 ½")						
Filter intake surface	810 cm ³	810 cm ³	810 cm ³	810 cm ³	810 cm ³	810 cm ³	810 cm ³
Max. coarse debris removal	8 mm	8 mm	8 mm	8 mm	8 mm	8 mm	8 mm
Setup type	Can be set up underwater & dry installed						
Electronic adjustment	Yes	Yes	Yes	Yes	Yes	Yes	Yes
Item no. (GB Version)	20241	20264	51098	51100	51103	51109	56710
Item no.	20225	20249	51096	51099	51102	51104	56653

THE POWERFUL CLASSIC – THAT IS NOW CONTROLLABLE!

AquaMax Eco Classic C



- **Fully economical:** The particularly energy-efficient motor in the AquaMax Eco Classic constantly saves electricity – and therefore money
- **Installation and maintenance:** Incredibly simple thanks to the secure connection to the controller
- **Environmental Function Control:** This is EFC, by OASE: no problems caused by the pump being blocked or running dry
- **OASE Switch:** The new AquaMax Eco-Classic C series with integrated controller can also be controlled using a separate app on your smartphone or tablet
- **Full control:** Easy to use via app or smartphone
- **Dirt be gone:** Reliable removal of plant parts or fish faeces up to a size of 8 mm
- **Everything included:** The special hose adapter with threaded collar for different hose sizes (25/32/38 mm) is included in the scope of delivery
- **Swimming and natural ponds:** Possible to use in an external pump vault

* **System requirements:** iOS 12.5 (Apple) or Android version 7.0 or later is required to use the app on mobile devices.



Smart control system

The new AquaMax Eco-Classic C series with integrated controller can also be controlled using a separate app on your smartphone or tablet



PRODUCT	AQUAMAX ECO CLASSIC 9000 C	AQUAMAX ECO CLASSIC 12000 C	AQUAMAX ECO CLASSIC 18000 C
Dimensions (L x W x H)	280 x 230 x 140 mm	280 x 230 x 140 mm	280 x 230 x 140 mm
Rated voltage	220–240 V / 50/60 Hz	220–240 V / 50/60 Hz	220–240 V / 50/60 Hz
Power consumption	23–90 W	26–120 W	33–175 W
Guarantee (+ request guarantee) ^{1p-131}	3 + 2 years	3 + 2 years	3 + 2 years
Max. flow rate (litres per hour)	8800 l/h	12,000 l/h	17,600 l/h
Max. head height, metres	4.50 m	4.70 m	5.30 m
Hose connection	25/32/38 mm (1", 1 ¼", 1 ½")	25/32/38 mm (1", 1 ¼", 1 ½")	25/32/38 mm (1", 1 ¼", 1 ½")
Filter intake surface	810 cm ²	810 cm ²	810 cm ²
Max. coarse debris removal	8 mm	8 mm	8 mm
Setup type	Can be set up underwater & dry installed	Can be set up underwater & dry installed	Can be set up underwater & dry installed
Electronic adjustment	Yes	Yes	Yes
Item no. (GB Version)	73339	73340	73341
Item no.	73336	73337	73338

EFFICIENT WATER MOVEMENT IN MULTIPLE POND ZONES

AquaMax Eco Premium

CORE 6 TECHNOLOGY

NEXT LEVEL EFFICIENCY

ECO

OASE CONTROL

VOICE CONTROL

5 YEARS* GUARANTEE 3+2



- **More efficient:** Improved efficiency on all six AquaMax Eco Premium 5000–21000 models
- **More economical:** Lower power consumption all year round thanks to the increased energy efficiency of the motors
- **Quieter:** Garden water features are more peaceful thanks to AquaMax Eco Premium pumps that are quieter than ever before
- **Fast switch-off:** Reliable protection against blockages and dry running thanks to the built-in OASE Environmental Function Control
- **Smart:** OASE Control interface for digital monitoring and control of the pump. A Garden Controller Cloud or InScenio FM-Master Cloud and other accessories (adapters, cables) are required to use the OASE Control functions
- **Demand-driven:** Seasonal Flow Control – now available on all models – increases efficiency by adjusting flow rates based on temperature
- **Suitable for cold weather:** Frost-proof down to -20°C
- **Compatible with the app:** Simply download the OASE Control app (from the App Store or Play Store) and off you go
- **Versatile:** You can place this pump in dry conditions or submerge it in water
- **Dirt be gone:** Reliable removal of plant debris or fish waste up to a size of 11 mm
- **»Made in Germany«:** Precise and reliable engineering skills at a particularly high level of quality



Dry installation
The AquaMax Eco Premium is also designed for dry installation (e.g. in a pump chamber).



SFC switch: Available on AquaMax Eco Premium 5000–21000. When the SFC function is switched on, the pump automatically optimises the water flow and delivery head, reducing them by up to 50%.

EXTRAS

USAGE IN THE SWIMMING POND

The AquaMax Eco Premium is also available as a 12 V version for safe use in swimming ponds and bathing ponds.

6000/12 V
12000/12 V

Item no. 50730
Item no. 50382

PRODUCT	NEW AQUAMAX ECO PREMIUM 5000	NEW AQUAMAX ECO PREMIUM 7000	NEW AQUAMAX ECO PREMIUM 9000	NEW AQUAMAX ECO PREMIUM 13000	NEW AQUAMAX ECO PREMIUM 17000	NEW AQUAMAX ECO PREMIUM 21000
Dimensions (L x W x H)	340 x 275 x 160 mm					
Rated voltage	220–240 V / 50/60 Hz					
Power consumption	10–35 W	12–45 W	14–60 W	16–100 W	18–140 W	20–180 W
Guarantee (+ request guarantee) ^{p-131}	3 + 2 years					
Max. flow rate (litres per hour)	5000 l/h	7000 l/h	9000 l/h	13,000 l/h	17,000 l/h	21,000 l/h
Max. head height, metres	3.50 m	4.00 m	4.50 m	5.00 m	5.50 m	6.00 m
Hose connection	25/32/38 mm (1", 1 ¼", 1 ½")			25/32/38/50 mm (1", 1 ¼", 1 ½", 2")		
Filter intake surface	1000 cm ²					
Max. coarse debris displacement	11 mm					
Setup type	For submerged or dry installation					
Electronic adjustment	Yes					
OASE Control connection	Yes					
Item no. (GB Version)	75928	85488	75929	75932	75933	75934
Item no.	75923	85487	75924	75925	75926	75927

PARTICULARLY POWERFUL WITH FLEXIBLE POWER ADJUSTMENT

AquaMax Eco Twin



- **Powerful:** High-performance filter pump, with the option to individually adjust the flow rate of the two motors via remote control
- **Highly economical:** By reducing power consumption and effectively adapting output to filter activity
- **Great:** Less maintenance thanks to large all-round filter
- **Dirt be gone:** Reliable removal of plant parts or fish faeces up to a size of 11 mm
- **Team-ready:** In addition to pond bottom filtration, it is also possible to connect a satellite filter or skimmer at the same time
- **Winter-proof:** This pump is damage-resistant down to temperatures as low as -20°C
- **Environmental Function Control:** Pump blockage and dry run protection thanks to EFC by OASE
- **"Made in Germany":** Precise and reliable engineering skills at a particularly high quality level
- **Swimming and natural ponds:** Can be used in an external pump chamber

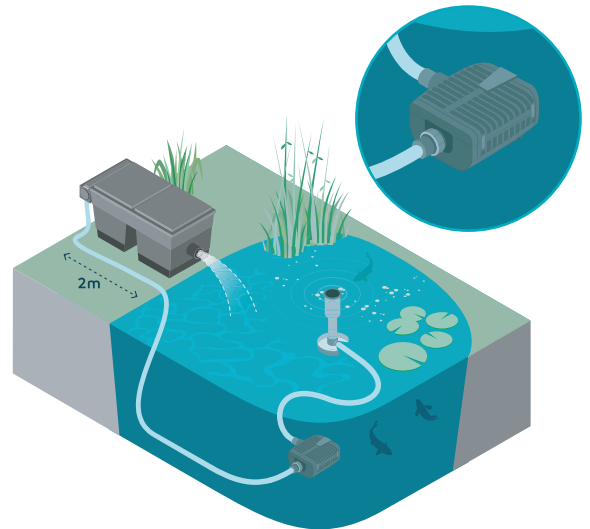

Small water worlds – big ideas.

EXTRAS

CONTROLLER WITH LED DISPLAY

The motors can be switched on or off separately or regulated together using a wireless remote control. Digital display of the respective power level.



PRODUCT

	AQUAMAX ECO TWIN 20000	AQUAMAX ECO TWIN 30000
Dimensions (L x W x H)	380 x 360 x 205 mm	380 x 360 x 205 mm
Rated voltage	220–240 V / 50/60 Hz	220–240 V / 50/60 Hz
Power consumption	20–198 W	20–320 W
Guarantee (+ request guarantee) ^{*)}	3 + 2 years	3 + 2 years
Max. flow rate	333 l/min	450 l/min
Max. flow rate (litres per hour)	20,000 l/h	27,000 l/h
Max. head height, metres	4.50 m	5.20 m
Hose connection	25/32/38/50 mm (1", 1 ¼", 1 ½", 2")	25/32/38/50 mm (1", 1 ¼", 1 ½", 2")
Filter intake surface	1300 cm ²	1300 cm ²
Max. coarse debris removal	11 mm	11 mm
Setup type	For submerged use only	For submerged use only
Electronic adjustment	Yes	Yes
Item no. (GB Version)	Not available in GB	-
Item no.	50708	50710

ENERGY-EFFICIENT POWERHOUSES FOR EVEN THE MOST DEMANDING SYSTEMS

AquaMax Eco Expert



- **Expert:** Perfect for use in demanding filter systems or for large watercourses and waterfalls
- **Durable:** The robust housing which also contains stainless steel is super durable
- **Environmental Function Control:** This is EFC, by OASE: no problems caused by the pump being blocked or running dry
- **Compatible with the app:** Simply download the OASE Control app (from the App Store or via GooglePlay), register and get started*
- **Dirt be gone:** Reliable removal of plant parts or fish faeces up to a size of 11 mm
- **SFC function:** Switch on and save up to 30% energy
- **"Made in Germany":** Precise and reliable engineering skills at a particularly high level of quality
- **Versatile:** You can place this pump in dry conditions or submerge it in water

* **System requirements:** A Garden Controller Cloud or InScenio FM-Master Cloud is required to use the OASE Control functions.



Winter-proof: This pump is damage-resistant down to temperatures as low as -20°C.



Connection for OASE Control units: The pump can be conveniently operated via innovative control devices such as the OASE Control unit or the Eco Control.



TIP

ECO CONTROL

With the clever control unit, the performance of the connected pumps can be monitored and regulated directly on the controller. Including illuminated display – without separate power supply!

Item no. 47673

12 V pumps
for swimming ponds and bathing ponds

PRODUCT	AQUAMAX ECO EXPERT 20000 / 12 V	AQUAMAX ECO EXPERT 27000 / 12 V	AQUAMAX ECO EXPERT 21000	AQUAMAX ECO EXPERT 26000	AQUAMAX ECO EXPERT 36000	AQUAMAX ECO EXPERT 44000
Dimensions (L x W x H)	490 x 240 x 210 mm	540 x 250 x 220 mm	490 x 240 x 210 mm		540 x 250 x 220 mm	
Rated voltage (primary, secondary)	220–240 V / 50–60 Hz, 12 V / DC		-	-	-	-
Rated voltage	-		220–240 V / 50/60 Hz			
Power consumption	30–260 W		40–350 W	60–440 W	90–540 W	140–700 W
Guarantee (+ request guarantee) ^{1p-131}	3 + 2 years	3 + 2 years	3 + 2 years	3 + 2 years	3 + 2 years	3 + 2 years
Max. flow rate (litres per hour)	19,300 l/h	27,000 l/h	21,000 l/h	26,000 l/h	36,000 l/h	44,000 l/h
Max. head height, metres	4.60 m	4.60 m	8.00 m	8.50 m	9.00 m	9.50 m
Hose connection	38/50 mm (1 1/2", 2")					
OASE Control connection	Yes	Yes	Yes	Yes	Yes	Yes
Filter intake surface	1060 cm ²	1120 cm ²	1060 cm ²	1060 cm ²	1120 cm ²	1120 cm ²
Max. coarse debris removal	11 mm	11 mm	11 mm	11 mm	11 mm	11 mm
Setup type	Can be set up underwater & dry installed					
Electronic adjustment	Yes	Yes	Yes	Yes	Yes	Yes
Item no. (GB Version)	-	-	-	-	-	-
Item no.	55313	77918	39916	39917	54614	54615

FULL FORCE AHEAD FOR GRAVITY-FED FILTER SYSTEMS – EVEN ON KOI PONDS!

AquaMax Eco Titanium



- **Think big:** Innovative, energy-efficient gravity filter pump for large bodies of water, even with koi stock
- **Power output:** Flow-optimised hydraulics help achieve an outstanding level of efficiency
- **Durable:** The rotor shaft and bearings are made of high-performance ceramic (silicon carbide or SIC ceramic) – for optimum reliability and longevity
- **Ideal:** Ideal for set-up in a pump vault
- **SFC function:** Switch on via optional accessories and save up to 30% energy on top
- **For universal use:** Suitable for submersed or dry use – even in saltwater
- **Super robust:** Pump housing made of stainless steel
- **"Made in Germany":** Precise and reliable engineering skills at a particularly high quality level
- **Compatible with the app:** Simply download the OASE Control app (from the App Store or via GooglePlay) and get started*

* **System requirements:** A Garden Controller Cloud or InScenio FM-Master Cloud is required to use the OASE Control functions.



Oasis of well-being: Get that holiday feeling in your own natural pool.



Robust pump housing: Cast stainless steel allows above-average levels of precision and energy-efficiency to be achieved sustainably. The entire pump housing can be adjusted upwards by 90°.



Connection for controllers: The pump can be conveniently operated via innovative control devices such as the OASE Control unit or the Eco Control.

PRODUCT	AQUAMAX ECO TITANIUM 31000	AQUAMAX ECO TITANIUM 51000	AQUAMAX ECO TITANIUM 81000
Dimensions (L x W x H)	275 x 175 x 200 mm	350 x 220 x 245 mm	390 x 235 x 245 mm
Rated voltage	220–240 V / 50/60 Hz	220–240 V / 50/60 Hz	220–240 V / 50/60 Hz
Power consumption	35–170 W	70–320 W	100–730 W
Guarantee (+ request guarantee) ^{1p, 131}	3 + 2 years	3 + 2 years	3 + 2 years
Max. flow rate (litres per hour)	31,500 l/h	51,000 l/h	81,000 l/h
Max. head height, metres	3.30 m	4.00 m	5.50 m
Pressure-side/suction-side connection	G 2 ½	G 3	G 3
OASE Control connection	Yes	Yes	Yes
Max. coarse debris removal	6 mm	6 mm	6 mm
Setup type	Can be set up underwater & dry installed	Can be set up underwater & dry installed	Can be set up underwater & dry installed
Electronic adjustment	Yes	Yes	Yes
Item no. (GB Version)	-	-	-
Item no.	73656	73657	77462

A decorative garden pond with a stone structure and green plants. The pond is surrounded by tall grasses and various green plants, including some with red flowers. The water is clear and reflects the surrounding foliage. A stone structure with two openings is visible in the pond, and a green hose is connected to it. The scene is brightly lit, suggesting a sunny day.

Filters, UVC clarifiers and aerators



Further information
is available at:
[www.oase.com/en/
filter-uvc-clarifiers](http://www.oase.com/en/filter-uvc-clarifiers)

32 Filter

- 32 **FILTERS COMPARED**
- 36 **UNDERWATER FILTERS**
- 37 **PRESSURE FILTERS**
- 39 **FLOW-THROUGH FILTERS**

43 Drum filters

- 43 **PROFICLEAR PREMIUM FLEECE**
- 44 **PROFICLEAR PREMIUM COMPACT**
- 46 **PROFICLEAR PREMIUM**
- 48 **PROFICLEAR PREMIUM XL**

52 UVC clarifiers/aerators

- 52 **UVC CLARIFIERS**
- 56 **AERATORS**

58 Ice preventer

- 58 **ICE PREVENTER**

Filters compared

A filter system essentially consists of:

- A filter pump to supply the filter
- A pond filter that provides bio-mechanical cleaning and
- a UVC clarifier to tackle floating algae and germs (already integrated in some filters).

As a rule of thumb, the following applies to determining the correct volume:



Pond volume in m³ = length x width x depth/2

(for rectangular ponds L x W x D only)

Example: 3 m x 4 m x 1 m/2 = 6 m³, which corresponds to 6000 litres

IMPORTANT NOTE

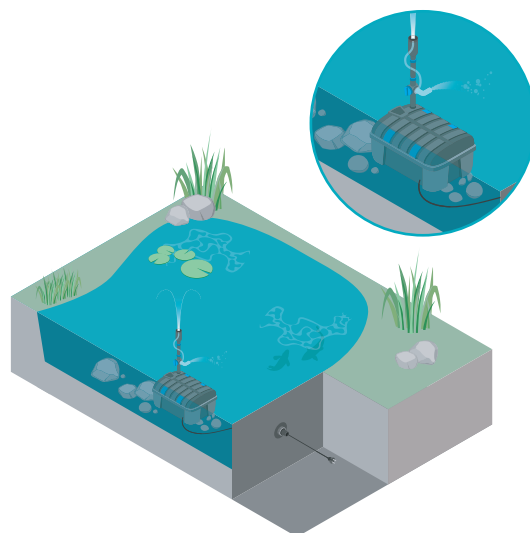

When **planning new ponds** with koi stock, please observe a minimum size of 5 m³!

-  Ponds with plants, without fish stock
-  Ponds with plants and fish stock up to 1 kg/1000 l
-  Ponds with plants and fish stock up to 1–2 kg/1000 l (koi ponds)



Underwater filters

With OASE underwater filters, even the tiniest space can become a mini water paradise.

SETS	UNDERWATER FILTERS	UVC POWER	FILTER & WATERCOURSE PUMP	+ AERATORS (ACCESSORIES)	SUITABLE FOR POND VOLUME IN M ³		ITEM NO. (GB VERSION)	ITEM NO.	
Table explanations: You will find the complete filter sets in the highlighted rows. The other configurations are additional possible combinations for different requirements and pond sizes.									
FILTRAL UVC									
Filtral UVC 1500	(Filter integrated)	5 W (UVC integrated)	(Pump integrated)	–	1.5	0.7	–	70236	70233
Filtral UVC 3000	(Filter integrated)	9 W (UVC integrated)	(Pump integrated)	–	3	1.5	–	70237	70234
Filtral UVC 6000	(Filter integrated)	11 W (UVC integrated)	(Pump integrated)	–	6	3	–	70238	70235
Filtral UVC 9000	(Filter integrated)	13 W (UVC integrated)	(Pump integrated)	–	9	4.5	–	70239	75952

Clear water guarantee (p. 131) according to Secchi up to a visibility depth of 1 m.

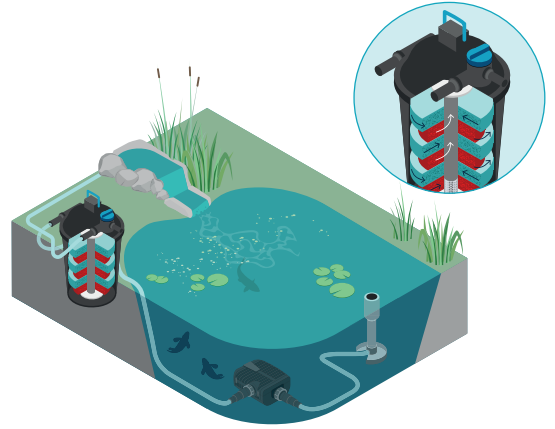

Pressure filter systems

Pressure filters are suitable for small to medium-sized ponds. If necessary, the water can be directed to higher watercourses, as the pump pressure is maintained through the filter.

SETS	PRESSURE FILTERS	UVC POWER	FILTER & WATERCOURSE PUMP	+ AERATORS (ACCESSORIES)	SUITABLE FOR POND VOLUME IN M ³			ITEM NO. (GB VERSION)	ITEM NO.
Table explanations: You will find the complete filter sets in the highlighted rows. The other configurations are additional possible combinations for different requirements and pond sizes.									
BIOPRESS									
Set 4000	BioPress 4000	7 W (UVC integrated)	FP 1500	–	4	2	–	50504	50499
Set 6000	BioPress 6000	9 W (UVC integrated)	FP 2500	–	6	3	–	50454	50453
Set 10000	BioPress 10000	14 W (UVC integrated)	FP 3500	–	10	5	–	50457	50455

Considerations for the BioPress sets: hose length of 5 m with a hose diameter of 1" and a delivery head of max. 0.5 m.

SETS	PRESSURE FILTERS	UVC POWER	FILTER & WATERCOURSE PUMP	+ AERATORS (ACCESSORIES)	SUITABLE FOR POND VOLUME IN M ³			ITEM NO. (GB VERSION)	ITEM NO.
Table explanations: You will find the complete filter sets in the highlighted rows. The other configurations are additional possible combinations for different requirements and pond sizes.									
FILTOCLEAR									
Set 5000	FiltoClear 5000	18 W (UVC integrated)	AquaMax Eco Premium 5000	–	5	2.5	–	77796	77784
	FiltoClear 13000	24 W (UVC integrated)	AquaMax Eco Premium 5000	+ OxyTex Set 500	5.5	2.75	–		
				–	13	7	–		
				+ OxyTex Set 500	14.3	7.7	–		
Set 13000	FiltoClear 13000	24 W (UVC integrated)	AquaMax Eco Premium 9000	–	13	7	–	77797	77785
				+ OxyTex Set 500	14.3	7.7	–		
	FiltoClear 19000	42 W (UVC integrated)	AquaMax Eco Premium 9000	–	19	10	5		
				+ OxyTex Set 500	23.75	12.5	6		
Set 19000	FiltoClear 19000	42 W (UVC integrated)	AquaMax Eco Premium 13000	–	20	10	5	77798	77786
				+ OxyTex Set 1000	25	12.5	6		
	FiltoClear 31000	60 W (UVC integrated)	AquaMax Eco Premium 13000	–	31	15	7.5		
				+ OxyTex Set 1000	38.75	18	9		
Set 31000	FiltoClear 31000	60 W (UVC integrated)	AquaMax Eco Premium 17000	–	31	15	7.5	77799	77787
				+ OxyTex Set 1000	38.75	18	9		

The above-mentioned pond size specifications (FiltoClear/sets) take into account delivery heads of 1 m and hose lengths of 5 m with a hose diameter of 1 1/2". Larger pumps should be used for longer hose lines and/or higher delivery heads. Clear water guarantee (p. 131) according to Secchi up to a visibility depth of 1 m. Please note that more intensive planning is required in the event of extreme temperature fluctuations, friction losses with hose lines of more than 5 m or strong solar radiation due to the specific location of the pond (south facing).



Filters compared

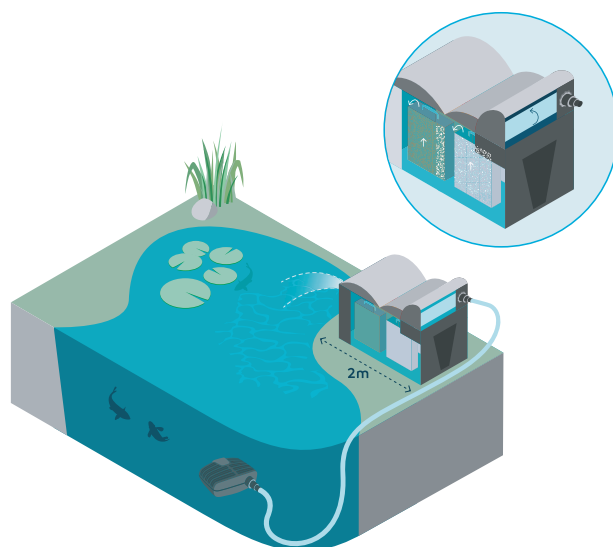

Flow-through filter systems

Flow-through filters are used for medium to large ponds as well as fish and koi ponds. They sit above the water level at the edge of the pond or above the stream, so the water flows back into the pond without pressure.

SETS	FLOW-THROUGH FILTERS	UVC PRE-CLARIFIER UVC POWER	FILTER & WATERCOURSE PUMP	+ AERATORS (ACCESSORIES)	SUITABLE FOR POND VOLUME IN M ³			ITEM NO. (GB VERSION)	ITEM NO.
Table explanations: You will find the complete filter sets in the highlighted rows. The other configurations are additional possible combinations for different requirements and pond sizes.									
BIOSMART									
Set 5000	BioSmart 5000	7 W (UVC integrated)	FP 1500	-	5	2.5	-	Not available in GB	50525
Set 7000	BioSmart 7000	9 W (UVC integrated)	FP 2500	-	7	3.5	-	50450	50449
Set 14000	BioSmart 14000	11 W (UVC integrated)	FP 3500	-	14	7	-	50452	50451
Set 18000	BioSmart UVC 16000	11 W (UVC integrated)	AquaMax Eco Classic 2500 E	-	8	4	-		
	BioSmart UVC 16000	11 W (UVC integrated)	AquaMax Eco Classic 3500 E	-	14	7	-		
Set 18000	BioSmart 18000	Vitronic 18 W	AquaMax Eco Classic 5500	-	18	9	-	56778	56777
Set 24000	BioSmart 24000	Vitronic 24 W	AquaMax Eco Classic 5500	-	24	12	6	56785	56781
Set 36000	BioSmart 36000	Vitronic 36 W	AquaMax Eco Classic 11500	-	36	18	9	56793	56789
	BioSmart 36000	Vitronic 36 W	AquaMax Eco Classic 8500	-	30	15	7.5		
Considerations for the BioSmart sets 5000/7000/14000/18000: hose length of 3 m with a hose diameter of ¾" and a delivery head of max. 0.5 m Considerations for the BioSmart sets 24000/36000: 5 m 1½" hose and a delivery head of max. 0.5 m									
FILTMATIC									
CWS set 7000	FiltoMatic CWS 7000	11 W (UVC integrated)	AquaMax Eco Premium 5000	-	7	3.5	-	Not available in GB	74456
CWS set 14000	FiltoMatic CWS 14000	24 W (UVC integrated)	AquaMax Eco Premium 7000	+ OxyTex Set 500	8.5	4.5	-		74458
				-	14	7	-		
CWS set 25000	FiltoMatic CWS 25000	24 W (UVC integrated)	AquaMax Eco Premium 9000	+ OxyTex Set 1000	17	8.5	-		74459
				-	25	12.5	7		
				+ OxyTex Set 1000	31	15.5	8.5		
The above-mentioned pond size specifications (FiltoMatic CWS) take into account delivery heads of 0 to 1.2 m and hose lengths of 5 m with a hose diameter of 1 ½". Larger pumps should be used for longer hose lines and/or higher delivery heads. Clear water guarantee (p. 131) according to Secchi up to a visibility depth of 1 m.									



TIP

FILTER SYSTEMS WITH CLEAR WATER GUARANTEE

OASE offers the optimal filter for every water world – from garden ponds with or without fish to ecological biotopes and modern water features. With clear water guarantee! More information can be found on p. 131 or at: www.oase.com

SETS	FLOW-THROUGH FILTERS	UVC PRE-CLARIFIER UVC POWER	FILTER & WATERCOURSE PUMP	+ AERATORS (ACCESSORIES)	SUITABLE FOR POND VOLUME IN M ³			ITEM NO. (GB VERSION)	ITEM NO.
Table explanations: You will find the complete filter sets in the highlighted rows. The other configurations are additional possible combinations for different requirements and pond sizes.									
BIOTEC									
Biotec Screen Matic² set 40000	BioTec ScreenMatic ² 40000	Bitron C 36 W	AquaMax Eco Premium 13000	–	40	20	10	74447	74445
Biotec Screen Matic² set 60000	BioTec ScreenMatic ² 60000	Bitron C 55 W	AquaMax Eco Premium 17000	–	60	30	15	74449	74448
Biotec Screen Matic² set 90000	BioTec ScreenMatic ² 90000	Bitron C 110 W	AquaMax Eco Premium 21000	–	72	36	18	74454	74450

The above-mentioned pond size specifications (BioTec) take into account delivery heads of 1 m and hose lengths of 5 m with a hose diameter of 1 1/2". Larger pumps should be used for longer hose lines and/or higher delivery heads. Clear water guarantee (p. 131) according to Secchi up to a visibility depth of 1 m. Please note that more intensive planning is required in the event of extreme temperature fluctuations, friction losses with hose lines of more than 5 m or strong solar radiation due to the specific location of the pond (south facing).

UNDERWATER FILTER WITH UVC AND WATER FEATURE

Filtral UVC

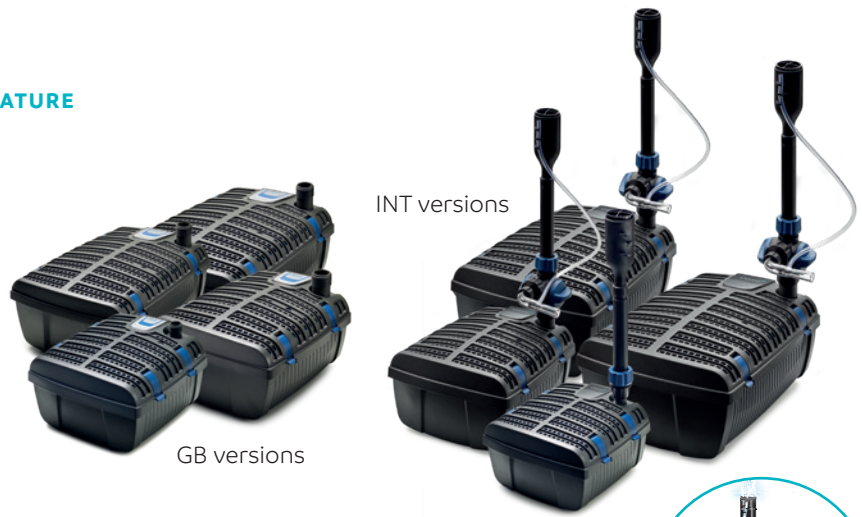

- **A good start:** Suitable for ponds up to 9 m³
- **Multi-talent:** With filter function, water feature and aeration nozzle (aeration nozzle included in delivery, from Filtral UVC 3000) Water feature and aeration nozzle available separately in GB
- **Guaranteed:** Includes OASE clear water guarantee
- **Control:** Individual control of water flow and fountain height
- **Adjustable:** Adjustable Y-distributor, for operating water spouts or small watercourses
- **Concealed:** Installation completely underwater, ensuring that the overall appearance of the pond remains undisturbed
- **Overview:** Thanks to UVC clarifier with optical function check

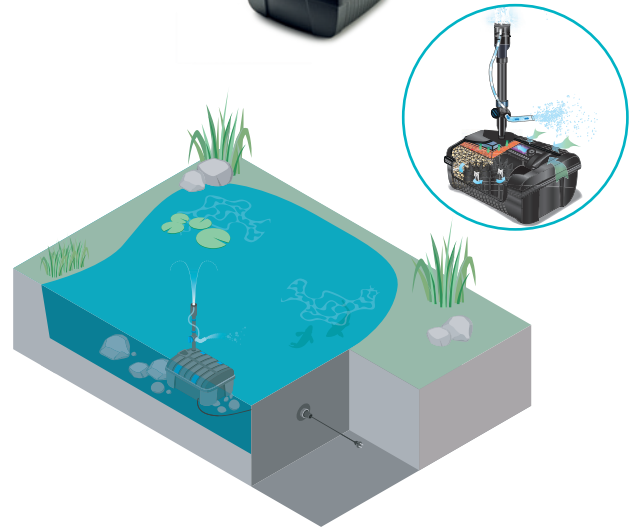

Joy and relaxation: Whether a gentle trickle or invigorating splashing – with the height-adjustable MAGMA, LAVA or VULCAN fountain attachments, you can bring variety to your water feature.

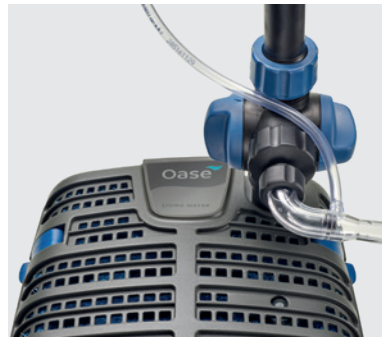

Innovative aeration function: The aeration nozzle provides additional oxygen input. A light flow is also generated in the pond, which leads to optimal filter results.

EXTRAS

ACCESSORIES

Filtral aeration set
Item no. 70364

Replacement sponge set Filtral UVC
 1500 **Item no. 70240**
 3000 **Item no. 70241**
 6000/9000 **Item no. 70242**



PRODUCT	FILTRAL UVC 1500	FILTRAL UVC 3000	FILTRAL UVC 6000	FILTRAL UVC 9000
Dimensions (L x W x H)	207 x 228 x 130 mm	269 x 245 x 140 mm	347 x 276 x 157 mm	347 x 276 x 157 mm
Power consumption	18 W	36 W	52 W	52 W
Power cable length	10.00 m	10.00 m	10.00 m	10.00 m
Warranty ^{1p-131}	2 years	2 years	2 years	2 years
UVC power	5 W	9 W	11 W	13 W
Max. pump output	750 l/h	1500 l/h	2500 l/h	2500 l/h
Max. flow rate (litres per hour)	560 l/h	1200 l/h	1700 l/h	1700 l/h
Max. head height, metres	0.90 m	1.80 m	2.10 m	2.10 m
Pressure-side connection	13 mm (½")	13/19/25 mm (½", ¾", 1")	13/19/25 mm (½", ¾", 1")	13/19/25 mm (½", ¾", 1")
Suitable for ponds up to max.	1.5 m ³	3.0 m ³	6.0 m ³	9.0 m ³
Suitable for ponds with fish stock	0.7 m ³	1.5 m ³	3.0 m ³	4.5 m ³
Item no. (GB Version)	70236	70237	70238	70239
Item no.	70233	70234	70235	75952

SOLID PRESSURE FILTER SET WITH UVC AND FILTER PUMP

BioPress sets



INT versions

- **Suitable for ponds up to 10 m³**
- **Clean:** Effective combination of mechanical/biological cleaning and effective UVC technology
- **Hats off:** Easier filter cleaning thanks to the patented cleaning function integrated in the lid
- **Guaranteed:** Includes OASE clear water guarantee
- **Let's get started:** Ideal for feeding elevated watercourses
- **Fast and easy:** With all the required hose connections – for quick and easy assembly



GB NON-SET VERSIONS

- 47601 BioPress 4000
- 47602 BioPress 6000
- 47603 BioPress 10000

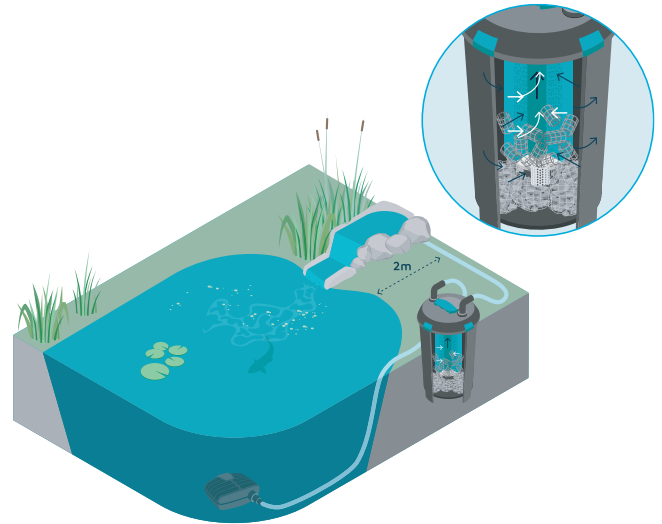

EXTRAS

RECOMMENDATION

To guarantee the full power of the UVC light waves, the UVC lamps should be replaced at regular intervals, ideally before the start of spring.

PRODUCT	BIOPRESS SET 4000	BIOPRESS SET 6000	BIOPRESS SET 10000
Dimensions (Ø x H)	225 x 335 mm	350 x 450 mm	350 x 570 mm
UVC power consumption	11 W	12 W	14 W
Pump power consumption	25 W	40 W	70 W
UVC power cable length	3.00 m	3.00 m	3.00 m
Pump power cable length	10.00 m	10.00 m	10.00 m
Warranty ^{*p. 131}	2 years	2 years	2 years
UVC power	7 W	9 W	11 W
Input/output connections	19/25/32/38 mm (¾", 1", 1 ¼", 1 ½")	19/25/32/38 mm (¾", 1", 1 ¼", 1 ½")	19/25/32/38 mm (¾", 1", 1 ¼", 1 ½")
Max. operating pressure	0.2 bar	0.2 bar	0.2 bar
Suitable for ponds up to max.	4.0 m ³	6.0 m ³	10.0 m ³
Suitable for ponds with fish stock	2.0 m ³	3.0 m ³	5.0 m ³
Suitable for ponds with koi ^{*1}	1.0 m ³	1.5 m ³	2.5 m ³
Item no. (GB Version)	50504	50454	50457
Item no.	50499	50453	50455

*1 Note: When planning new ponds with koi stock, please observe a minimum size of 5 m³!

EFFECTIVE AND CONVENIENT PRESSURE FILTER

FiltoClear



- **Suitable for ponds up to 31 m³**
- **Cleaners:** Patented cleaning mechanism with optimised filter sponges
- **Convenient:** Easy to maintain and clean thanks to the simple pull-out mechanism
- **Easy to replace the lamp:** The UV lamp can be replaced during operation – no need to switch off the filter or dismantle the quartz glass
- **Secured:** The high-quality UVC housing protects the ballast from sunlight and moisture
- **2-way valve:** Select whether the water flows into the pond or into the waste water after cleaning the filter
- **Efficiency improvement:** The built-in OASE bypass technology ensures optimum water flow and prevents the filter from becoming clogged
- **High performance:** All the latest FiltoClear models feature upgraded, highly effective UV lamps
- **Strong and robust:** The tough housing made of high-quality plastic is easy to dig into the ground and impresses with its long durability
- **Clever:** The metal clamping ring with simple lever function makes opening and closing a FiltoClear easier and safer than ever
- **Guaranteed:** Includes OASE clear water guarantee

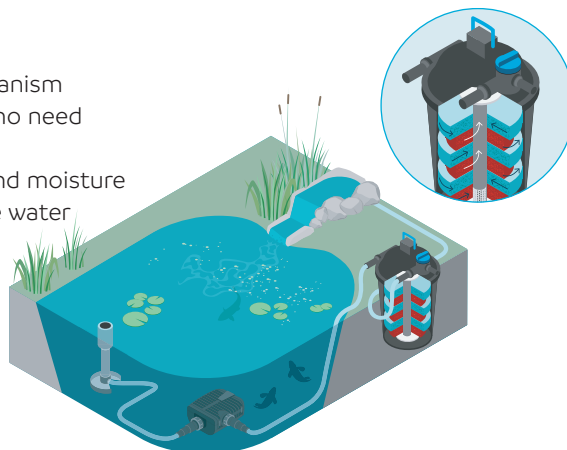

Convenient cleaning: Filter sponges can be cleaned quickly and easily using the patented pull-out mechanism.

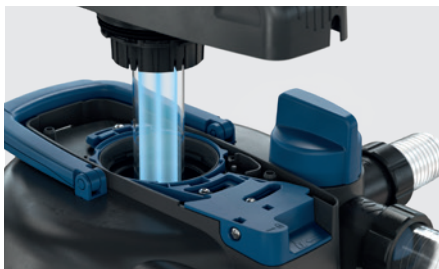

Easy to replace the lamp: The UV housing can be easily removed during operation for replacing the integrated UV lamp.



Targeted drainage of dirty water: The dirty water is drained from the cleaned filter sponges via the two-way valve, for example into a flower bed.

PRODUCT	FILTOCLEAR 5000	FILTOCLEAR 13000	FILTOCLEAR 19000	FILTOCLEAR 31000
Dimensions (Ø x H)	380 x 370 mm	380 x 488 mm	380 x 608 mm	380 x 728 mm
Power consumption	18 W	24 W	42 W	60 W
Power cable length	5.00 m	5.00 m	5.00 m	5.00 m
Guarantee (+ request guarantee)^{*)}	2 + 1 years	2 + 1 years	2 + 1 years	2 + 1 years
UVC power	18 W	24 W	42 W	60 W
Inlet connections	38/50 mm (1 ½", 2")	38/50 mm (1 ½", 2")	38/50 mm (1 ½", 2")	38/50 mm (1 ½", 2")
Outlet connections	38/50 mm (1 ½", 2")	38/50 mm (1 ½", 2")	38/50 mm (1 ½", 2")	38/50 mm (1 ½", 2")
Sludge discharge connections	38/50 mm (1 ½", 2")	38/50 mm (1 ½", 2")	38/50 mm (1 ½", 2")	38/50 mm (1 ½", 2")
Max. flow rate (litres per hour)	5000 l/h	9000 l/h	13,000 l/h	17,000 l/h
Max. operating pressure	0.2 bar	0.2 bar	0.2 bar	0.2 bar
Suitable for ponds up to max.	5.0 m ³	13.0 m ³	19.0 m ³	31.0 m ³
Suitable for ponds with fish stock	2.5 m ³	7.0 m ³	10.0 m ³	15.0 m ³
Suitable for ponds with koi^{*)}	–	–	5.0 m ³	7.5 m ³
Item no. (GB Version)	77788	77789	77790	77791
Item no.	77776	77777	77778	77779

^{*)} Note: When planning new ponds with koi stock, please observe a minimum size of 5 m³!

SOLID FLOW FILTER FOR GARDEN PONDS

BioSmart sets



- **Suitable for ponds up to 36 m³**
- **Fish-friendly:** Additional oxygen enrichment through special water supply
- **All clear:** Guarantees clear pond water by combining mechanical/biological cleaning with effective UVC technology
- **Perfect fit:** Optimally adapted to the OASE AquaMax filter and watercourse pumps
- **Benefit:** Easy to hide as the filter housing can be buried to μ of its height
- **Included:** Displays showing the degree of soiling and water temperature
- **Guaranteed:** Includes OASE clear water guarantee
- **Perfect package:** Incl. 100 ml BioKick filter starter*2

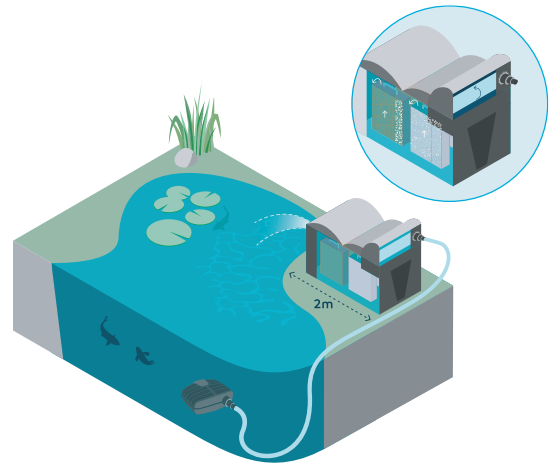

Very easy maintenance: After actuating the cleaning lever, the bottom drain can be opened and coarse dirt can be disposed of (BioSmart 18000/36000 only).



Nitrification and denitrification zone: Toxic degradation products such as ammonium, ammonia, nitrite and nitrate are effectively broken down in the various sponges.

EXTRAS

BIOSMART

The flow-through filter BioSmart is also available as a single filter in sizes 16000, 18000 and 36000.

PRODUCT	BIOSMART SET 5000	BIOSMART SET 7000	BIOSMART SET 14000	BIOSMART SET 18000	BIOSMART SET 24000	BIOSMART SET 36000
Dimensions (L x W x H)	280 x 380 x 410 mm		380 x 560 x 410 mm	559 x 596 x 408 mm	920 x 555 x 405 mm	920 x 600 x 405 mm
UVC power consumption	11 W	12 W	14 W	18 W	24 W	36 W
Pump power consumption	25 W	40 W	70 W	60 W	60 W	100 W
UVC power cable length	3.00 m	3.00 m	3.00 m	5.00 m	5.00 m	5.00 m
Pump power cable length	10.00 m	10.00 m	10.00 m	10.00 m	10.00 m	10.00 m
Warranty¹ *131	2 years	2 years	2 years	2 years	2 years	2 years
UVC power	7 W	9 W	11 W	18 W	24 W	36 W
Inlet connections	19/25/32/38 mm (¾", 1", 1 ¼", 1 ½")					
Outlet connections	DN 50	DN 50	DN 75	DN 75	DN 75	DN 75
Sludge discharge connections	38 mm (1 ½")	38 mm (1 ½")	38 mm (1 ½")	DN 50	DN 50	DN 50
Suitable for ponds up to max.	5.0 m ³	7.0 m ³	14.0 m ³	18.0 m ³	24.0 m ³	36.0 m ³
Suitable for ponds with fish stock	2.5 m ³	3.5 m ³	7.0 m ³	9.0 m ³	12.0 m ³	18.0 m ³
Suitable for ponds with koi¹	1.3 m ³	1.7 m ³	3.5 m ³	4.5 m ³	6.0 m ³	9.0 m ³
Item no. (GB Version)	Not available in GB	50450	50452	56778	56785	56793
Item no.	50525	50449	50451	56777	56781	56789

¹ Note: When planning new ponds with koi stock, please observe a minimum size of 5 m³! ² BioSmart Set 18000–36000 only

POND MANAGER WITH AUTOMATIC SELF-CLEANING

FiltoMatic CWS



- **Suitable for ponds up to 25 m³**
- **Intelligent:** The automatic control system adjusts the filter performance to the seasonal needs of the pond
- **Goodbye mud:** Automatic mud discharge, meaning less cleaning effort
- **Economical:** Up to 40% energy savings through demand-driven UVC unit with patented self-cleaning and oxygen enrichment
- **Guaranteed:** Includes OASE clear water guarantee
- **Discreet:** Almost invisible; can be buried up to 70% at the edge of the pond
- **Convenient:** The filter sponges are especially easy to clean
- **Sophisticated:** Long service life combined with high-quality filter sponges provide optimal conditions for the filter biology
- **Goodbye algae:** Less thread algae due to constant phosphate and nutrient discharge
- **Interval cleaning:** UVC and pump function can also be controlled manually
- **Compact:** Particularly space-saving design
- **Clever design:** The UVC operating hours meter indicates when to replace bulbs

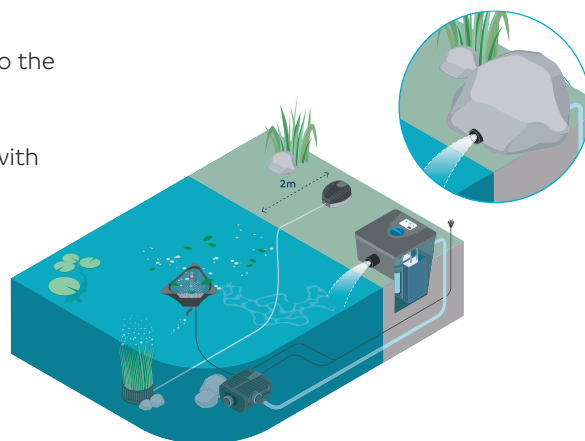

Cleaning: In addition to the fully automatic sludge discharge, sponge cleaning is carried out conveniently and without getting your hands dirty.

EXTRAS

AUTOMATIC CONTROL UNIT

The innovative control system ensures energy savings due to the temperature-controlled UVC unit and automatic cleaning intervals.



PRODUCT	FILTOMATIC CWS 7000	FILTOMATIC CWS 14000	FILTOMATIC CWS 25000
Dimensions (L x W x H)	380 x 380 x 520 mm	380 x 380 x 720 mm	380 x 580 x 720 mm
Power consumption	17 W	27 W	27 W
Power consumption, cleaning	41 W	54 W	54 W
Power cable length	10.00 m	10.00 m	10.00 m
Guarantee (+ request guarantee) ^{*p.131}	2 + 1 years	2 + 1 years	2 + 1 years
UVC power	11 W	24 W	24 W
Inlet connections	38 mm (1 1/2")	38 mm (1 1/2")	38 mm (1 1/2")
Outlet connections	DN 75	DN 75	DN 75
Sludge discharge connections	DN 40	DN 40	DN 40
Min. flow rate	2500 l/h	3500 l/h	3500 l/h
Max. flow rate (litres per hour)	4000 l/h	5000 l/h	6000 l/h
Suitable for ponds up to max.	7.0 m ³	14.0 m ³	25.0 m ³
Suitable for ponds with fish stock	3.5 m ³	7.0 m ³	12.5 m ³
Suitable for ponds with koi ^{*1}	2.0	3.5 m ³	6.5 m ³
Item no. (GB Version)	Not available in GB		
Item no.	50906	50910	50925

*1 Note: When planning new ponds with koi stock, please observe a minimum size of 5 m³!

HIGH-PERFORMANCE FILTER WITH AUTOMATIC COARSE DIRT SEPARATION

BioTec ScreenMatic²



- **Highly effective flow-through filter for ponds up to 145 m³**
- **Convenient:** Filter sponges can be cleaned directly in the filter
- **Guaranteed:** Includes OASE clear water guarantee
- **Low maintenance:** Coarse dirt is removed before it enters the filter
- **Self-cleaning:** The filter belt is automatically driven; adjustable automatic cleaning system, which controls the belt run based on the degree of contamination, including LED function check
- **Mess-free:** Bottom drain with slide to remove dirt from the filter system
- **Smart combo:** Different filter media for optimal development of filter biology
- **Extra protection against thread algae:** Use of PhosLess filter cartridges for reducing thread algae (optional accessory)
- **Suitable pumps:** Optimally matched to OASE AquaMax Eco filter pumps
- **Good partners:** Direct connection option for UVC Bitron C and Eco clarifiers
- **No clogging:** Uniform water distribution on the filter belt
- **Practical:** Large-volume dirt basket with simplified handling

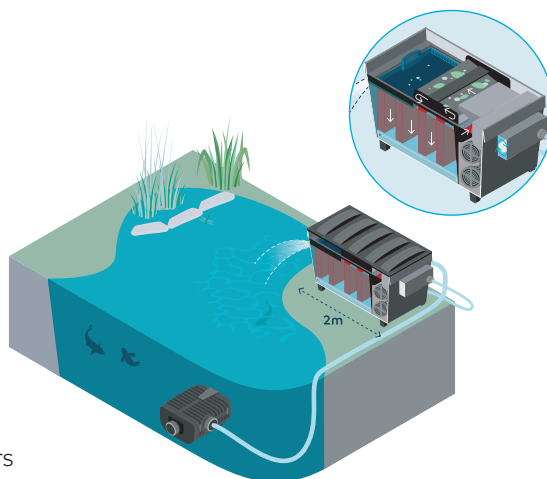

Optimised continuous belt: Continuous belt is easy to fold up and makes it easy to clean filter sponges.

PRODUCT	BIOTEC SCREENMATIC ² 4000	BIOTEC SCREENMATIC ² 6000	BIOTEC SCREENMATIC ² 9000	BIOTEC SCREENMATIC ² 14500
Dimensions (L x W x H)	788 x 590 x 445 mm	788 x 590 x 545 mm	788 x 590 x 645 mm	1334 x 891 x 815 mm
Power consumption	5 W	5 W	5 W	5 W
Cable length for 12 V device	2.10 m (power supply unit) + 5.00 m	2.10 m (power supply unit) + 5.00 m	2.10 m (power supply unit) + 5.00 m	2.10 m (power supply unit) + 5.00 m
Guarantee (+ request guarantee)¹	2 + 1 years	2 + 1 years	2 + 1 years	2 + 1 years
Special filter granules	2.50 kg	3.50 kg	5.00 kg	14.50 kg
Coarse debris extraction	300 µm	300 µm	300 µm	300 µm
Inlet connections	25/32/38 mm (1", 1 ¼", 1 ½")		25/32/38/50 mm (1", 1 ¼", 1 ½", 2")	
Outlet connections	DN 75	DN 75	DN 110	DN 110
Sludge discharge connections	DN 50	DN 50	DN 50	DN 110
Max. flow rate (litres per hour)	9000 l/h	11,000 l/h	12,500 l/h	17,500 l/h
Suitable for ponds up to max.	40.0 m ³	60.0 m ³	90.0 m ³	145.0 m ³
Suitable for ponds with fish stock	20.0 m ³	30.0 m ³	45.0 m ³	72.0 m ³
Suitable for ponds with koi¹	10.0 m ³	15.0 m ³	22.5 m ³	36.0 m ³
Connection to	Bitron C 36–110 W, Bitron Eco 120–240 W			
Item no. (GB Version)	-	-	-	-
Item no.	57694	57695	46178	93037

¹ Note: When planning new ponds with koi stock, please observe a minimum size of 5 m³!

COMPACT HIGH-PERFORMANCE FILTER WITH DRUM FILTER TECHNOLOGY

BioTec Premium

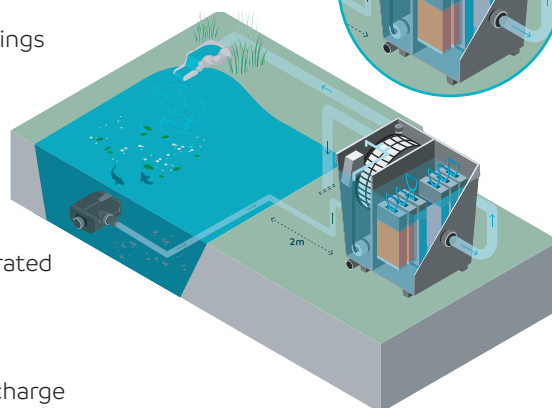
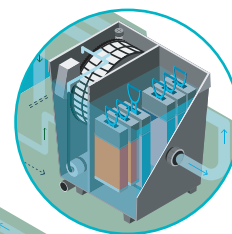

- **Clever:** Intelligent filter system for natural ponds up to 80 m³ and for fish ponds up to 40 m³
- **Good riddance:** Dirt drain including gate valve
- **No more dirt:** Thanks to the drum filter technology, the fully automatic coarse dirt separation system simply flushes the dirt out of the filter
- **Smart:** By connecting to the OASE Control system, you can control all settings conveniently via the app; it is possible to upgrade existing systems using a separately available upgrade kit
- **Performance:** A long service life and high-quality filter sponges create optimal living conditions for the filter bacteria, ensuring full performance
- **Water-saving:** The filter is rinsed exclusively with purified pond water – a fresh water connection is not required
- **Thorough-clean:** A high-performance, high-quality pressure pump is integrated to rinse the drum
- **Pre-clean:** Dirt rakes on the sieves reliably remove thread algae and larger particles from the drum
- **Reduction:** Less thread algae due to constant phosphate and nutrient discharge
- **Guaranteed:** Includes OASE clear water guarantee
- **No tools:** Easy access to the inside of the drum through individually removable sieve elements and freewheel function
- **Shhh:** Particularly quiet operation thanks to extensive noise insulation

* **System requirements:** A Garden Controller Cloud or InScenio FM-Master Cloud is required to use the OASE Control functions.



Intelligent control centre: A waterproof microcontroller system monitors and controls the main functions with easy operation (Plug 'n' Play).



Smart drum filter technology: The innovative and self-cleaning pre-separator reliably separates water and solid particles up to 125 micron and does so without any additional cleaning effort.

PRODUCT	BIOTEC PREMIUM 80000 PUMPED
Dimensions (L x W x H)	830 x 675 x 820 mm
Power consumption	5 W
Power consumption, cleaning	670 W
Cable length	5.00+ 1.00 m
Guarantee (+ request guarantee) ^{*)}	2 + 1 years
Control unit	Microcontroller
Temperature display	Digital
Coarse debris extraction	125 µm
Number of nozzles/rinse quantity	1 x 4.0 l/min
Scavenging pump	4 bar
Flush automation	Manual, sensor, time interval
Inlet connections	1 x 2" + Bitron
Connection to	Bitron C 36–110 W, Bitron Eco 120–240 W, ProfiClear Classic
Outlet connections	DN 110
Sludge discharge connections	DN 75
Flush trough connection	DN 110
Min. flow rate	7500 l/h
Max. flow rate (litres per hour)	12,500 l/h
Suitable for ponds up to max.	80.0 m ³
Suitable for ponds with fish stock	40.0 m ³
Suitable for ponds with koi ^{†)}	20.0 m ³
Item no. (GB Version)	Not available in GB
Item no.	54850

*^{†)} Note: When planning new ponds with koi stock, please observe a minimum size of 5 m³!

DOUBLE-ACTING FLEECE FILTERS WITH SMART FUNCTION FOR KOI PONDS



ProfiClear Premium Fleece

- **Suitable for ponds up to 144.0 m³**
- **Three-fold effect:** Finest depth filtration, coupled with highly dimensioned filter biology due to the Hel-X material and clear wave blocks, creates an even larger colonisation area
- **Full control:** Interface to the OASE Control System for digital monitoring of water temperature and fleece usage*
- **Compact design:** Enables use as a new filter or as a retrofit filter in existing systems; compatible with the modules of the ProfiClear L series
- **Easy care:** Easy replacement of the fleece rolls thanks to easy-to-use roller bearings
- **Pond-specific:** Available for koi ponds up to 26,000 or 38,000 l

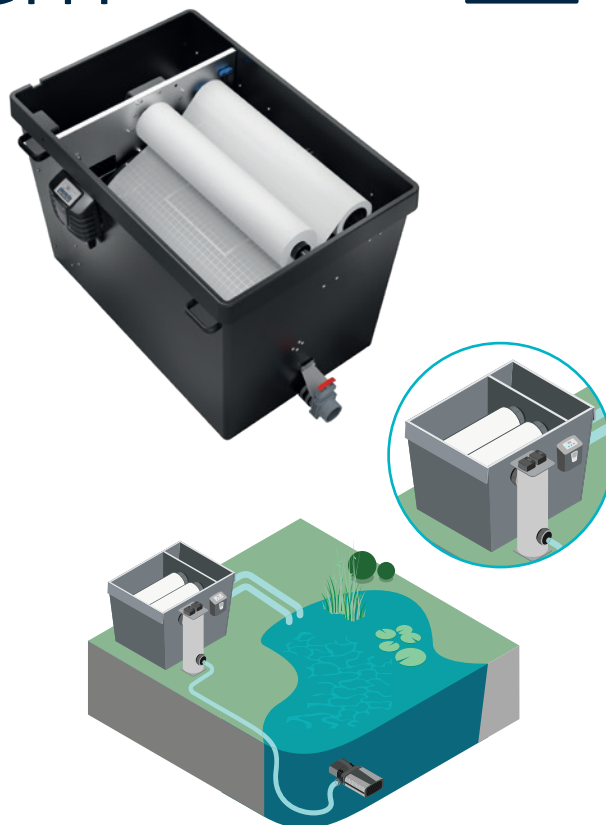

* **System requirements:** A Garden Controller Cloud or InScenio FM-Master Cloud is required to use the OASE Control functions.

ACCESSORIES

REPLACEMENT FLEECE 500

Original replacement fleece for refitting the ProfiClear Premium Fleece 500 in optimal quality.

Item no. 90823

REPLACEMENT FLEECE 750

Original replacement fleece for refitting the ProfiClear Premium Fleece 750 in optimal quality.

Item no. 90824



PRODUCT	NEW PROFICLEAR PREMIUM FLEECE 500	NEW PROFICLEAR PREMIUM FLEECE 750
Dimensions (L x W x H)	1370 x 890 x 835 mm	1370 x 890 x 835 mm
Rated voltage	230 V / 50 Hz	230 V / 50 Hz
Power consumption	5 W	5 W
Power consumption, cleaning	-	-
Power cable length	5.00+ 5.00 m	5.00+ 5.00 m
Net weight	95.00 kg	100.00 kg
Guarantee (+ request guarantee) ^{*p-131}	2 + 1 years	2 + 1 years
Control unit	Microcontroller	Microcontroller
Temperature display	Digital	Digital
Fleece width	500 mm	750 mm
Biofilter media	Hel-X 36/ClearWave	Hel-X 36/ClearWave
Volume in litres	74 Hel-X	111 Hel-X
ClearWave volume in litres	84	36
Material	GFK Duroplast/stainless steel/plastic	
Inlet connections	1 x DN 110 / 2 x Tradux 2" with non-return valve, Bitron Premium, Bitron Eco, Bitron C	
OASE Control connection	Yes	Yes
Outlet connections	2 x DN 110 / 2 x DN 150	3 x DN 110 / 2 x DN 150
Sludge discharge connections	DN 75	DN 75
Min. flow rate	5000 l/h	7500 l/h
Max. flow rate (litres per hour)	17,000 l/h	25,000 l/h
Suitable for ponds up to max.	104.0 m ³	144.0 m ³
Suitable for ponds with fish stock	52.0 m ³	72.0 m ³
Suitable for ponds with koi ¹²	26.0 m ³	36.0 m ³
Item no. (GB Version)	Not available in GB	-
Item no.	75218	75219

*1 Note: When planning new ponds with koi stock, please observe a minimum size of 5 m³!

COMPACT, POWERFUL DRUM FILTER – FOR SMALL PONDS

ProfiClear Premium Compact

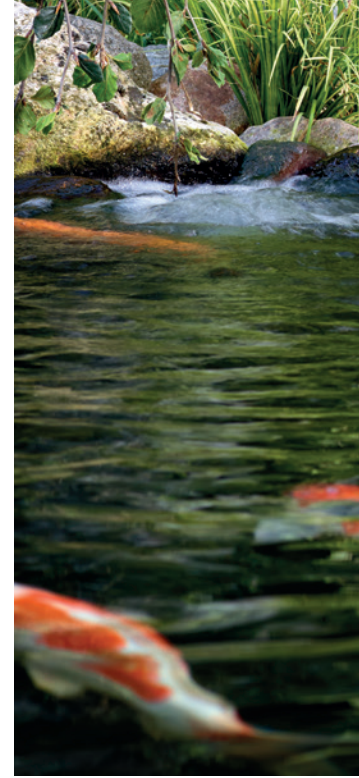

- **Suitable for ponds up to 140 m³**
- **Smart:** Conveniently control all settings via an app with connection options for the OASE Control system; existing systems can be upgraded using the separately available upgrade kit*
- **Value for money:** More cost-effective alternative for smaller ponds, especially koi ponds
- **Clean:** The fully automatic coarse dirt separation simply rinses the dirt out of the filter thanks to drum filter technology
- **Flexible:** Available as a pumped system or a gravity system
- **Optimised:** With Moving Bed System for optimal water movement and cleaning
- **Clear:** High separation performance due to deep filtration of up to 60 µm

- **Effective:** Hel-X 13 filter medium with a particularly large surface area for effective degradation of nutrients and pollutants
- **"Made in Germany":** Precise and reliable engineering skills with particularly high quality (except pressure pump)
- **Automatic:** The filter is flushed exclusively with cleaned pond water
- **A feast for your ears:** Particularly quiet operation thanks to extensive noise insulation
- **Easy:** Individually removable sieve elements (without tools) and free-running function
- **Reliable:** Dirt screens on the sieves protect against thread algae and larger particles
- **Flat:** Low installation height for full flexibility in gravitational systems

* **System requirements:** A Garden Controller Cloud or InScenio FM-Master Cloud is required to use the OASE Control functions.

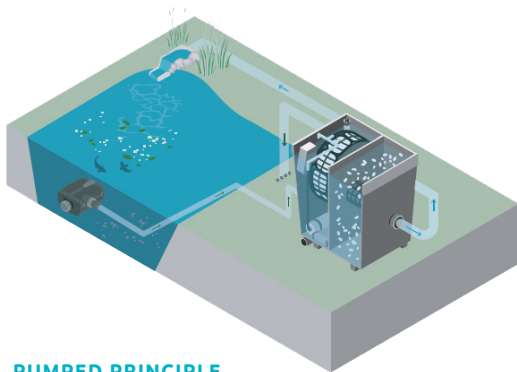

PUMPED PRINCIPLE

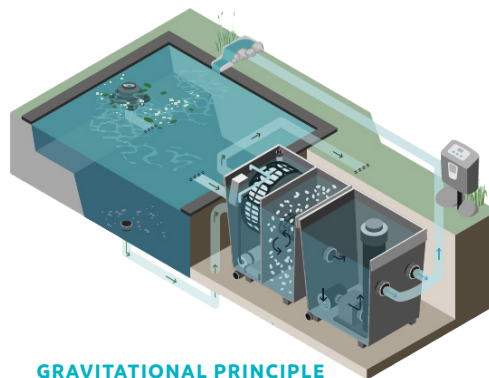

GRAVITATIONAL PRINCIPLE

PRODUCT

- Dimensions (L x W x H)
- Power consumption
- Power consumption, cleaning
- Cable length
- Guarantee (+ request guarantee) ^{10, 131}
- Control unit
- Coarse debris extraction
- Number of nozzles/rinse quantity
- Scavenging pump
- Flush automation
- Biological filter surface
- Protected biological filter surface
- Inlet connections
- Inlet connections
- Connection to
- Outlet connections
- Sludge discharge connections
- Flush trough connection
- Min. flow rate
- Max. flow rate (litres per hour)
- Suitable for ponds up to max.
- Suitable for ponds with fish stock
- Suitable for ponds with koi ¹¹
- Type of use
- Installation height above water level
- Other
- Item no. (GB Version)
- Item no.



					
PROFICLEAR PREMIUM COMPACT-M PUMPED	PROFICLEAR PREMIUM COMPACT-M GRAVITY	PROFICLEAR PUMP CHAMBER COMPACT/ CLASSIC	PROFICLEAR PREMIUM COMPACT-L PUMPED OC	PROFICLEAR PREMIUM COMPACT-L GRAVITY	PROFICLEAR PREMIUM INDIVIDUAL MODULE
885 x 685 x 820 mm	885 x 685 x 820 mm	830 x 665 x 820 mm	1334 x 891 x 815 mm	1370 x 891 x 815 mm	830 x 600 x 820 mm
5 W	5 W	-	5 W	5 W	5 W
670 W	670 W	-	1050 W	1050 W	-
5.00+1.00 m	5.00+5.00 m	-	5.00+1.00 m	5.00+5.00 m	-
2 + 1 years	2 + 1 years	2 + 1 years	2 + 1 years	2 + 1 years	2 + 1 years
Microcontroller	Microcontroller	-	Microcontroller	Microcontroller	-
80 µm	80 µm	-	60 µm	60 µm	-
2 x 3.5 l/min	2 x 3.5 l/min	-	4 x 2.5 l/min	4 x 2.5 l/min	-
4 bar	4 bar	-	6 bar	6 bar	-
Manual, sensor, time interval	Manual, sensor, time interval	-	Manual, sensor, time interval	Manual, sensor, time interval	-
38.2 m ²	38.2 m ²	-	57.3 m ²	57.3 m ²	-
32.2 m ²	32.2 m ²	-	48.5 m ²	48.5 m ²	-
50 mm	-	-	50 mm	-	180 mm
1 x 2" + Bitron	DN 110	-	1 x 2" + Bitron	DN 110	2 x 185 mm
AquaOxy 2500, Bitron C 72-110 W, Bitron Eco 120-240 W	AquaOxy 2500, Bitron Premium, ProfiClear pump chamber Compact	Aquamax Eco Gravity, Bitron Premium, ProfiClear Classic	AquaOxy 2500, Bitron C 72-110 W, Bitron Eco 120-240 W	AquaOxy 2500, Bitron Premium, ProfiClear Moving Bed Module	AquaOxy 2500, Bitron Premium
DN 110	DN 110	1 x 2" / 2 x DN 110	DN 110	DN 150	2 x 2" / 2 x DN 110
DN 75, DN 110	DN 75, DN 110	DN 75	DN 75, DN 110	DN 75, DN 110	DN 75
DN 110	DN 110	-	DN 110	DN 110	-
7500 l/h	7500 l/h	-	10,000 l/h	10,000 l/h	10,000 l/h
12,500 l/h	16,500 l/h	25,000 l/h	20,000 l/h	25,000 l/h	33,000 l/h
80.0 m ³	88.0 m ³	-	120.0 m ³	140.0 m ³	-
40.0 m ³	44.0 m ³	-	60.0 m ³	70.0 m ³	-
20.0 m ³	22.0 m ³	-	30.0 m ³	35.0 m ³	-
Pump system	Gravity	Gravity, pump system	Pump system	Gravity	Gravity, pump system
32.0 cm	10.5 mm	10.5 mm	37.0 cm	12.5 cm	11.5 cm
Ventilation pre-installed, dirt drain incl. pull-out valve, incl. 40 l Hel-X 13 biomedium		Dirt drain incl. pull-out valves	Ventilation pre-installed, incl. 60 l Hel-X 13 biomedium		Dirt drain incl. pull-out valves
47009	47011	-	49980	49982	-
47008	47010	42913	49979	49981	50771



ProfiClear Premium



1 DRUM FILTER MODULE: 2 MOVING BED MODULE 3 INDIVIDUAL MODULE

- **Smart high-end modular filter system for koi ponds and other large bodies of water up to 260 m³**
 - **Modern:** Modular filter system for professional water quality where space is at a minimum
 - **Tried-and-tested:** Mature, professional technology with over three years of development time
 - **Clean:** Filtration with a filtration capacity of up to 60 µm and fully automatic self-cleaning
 - **Control:** Suitable for outdoor use, the microcontroller monitors and controls the functions
 - **Easy:** Individually removable sieve elements (without tools) and free-running function for easy access to the drum
 - **A feast for your ears:** Particularly quiet when operating
 - **Powerful:** High-quality high-pressure pump for flushing the drum is included in the delivery
 - **Effective:** Excellent decomposition rates of ammonium, ammonia, nitrite and nitrate
 - **Smart:** Conveniently control all settings via an app with connection options for the OASE Control system; existing systems can be upgraded using the separately available upgrade kit*
 - **Moving Bed:** Highly effective at breaking down pollutants and nutrients using purpose-designed filter media in the Moving Bed System
 - **Drum filter module:** Intelligent self-cleaning function for uniquely maintenance-free operation
 - **Individual module:** Flexible adaptation of the filter system to meet individual requirements
 - **"Made in Germany":** Precise and reliable engineering skills with particularly high quality (except pressure pump)
 - **No jamming:** Safety level switch in the pumped system prevents blockages due dirt particles
 - **Flexible:** Additional 2" inputs with non-return valve for the integration of further pumps
 - **Run free:** Flow rate up to 25 m³/h
- * **System requirements:** A Garden Controller Cloud or InScenio FM-Master Cloud is required to use the OASE Control functions.



Quiet operation: Extremely quiet due to extensive noise insulation.



Easy handling: The filter elements can easily be removed and replaced.

1

DRUM FILTER MODULE:

Intelligence sets the pace. The intelligent control centre removes coarse dirt up to 60 µm – that is finer than a hair.

- Highest filter performance up to 60 µm and flow rates up to 33 m³/h for crystal clear visibility
- Fully automated self-cleaning system provides maximum convenience
- Flushing is carried out by purified pond water, no water connection required
- A waterproof microcontroller system monitors and controls the main functions with easy operation (Plug 'n' Play)
- Particularly quiet operation due to extensive noise insulation
- Integrated high-performance high-quality pressure pump for flushing the drum

2

MOVING BED MODULE

Hel-X causes quite a stir. Original Hel-X biomedias are highly effective at breaking down nutrients and pollutants in the Moving Bed System.

- Extremely large protected settlement surface for microorganisms (806 m²/m³)
- Innovative bypass technology for optimal movement of the Hel-X biobodies even at high flow rates
- Removal of toxins, such as ammonium/ammonia, nitrite and nitrate
- Hel-X biomedias: 50 litres remove about 340 g of fish food per day. Its performance depends on temperature, feed quality and the degree of colonisation with microorganisms
- Benefits of the Moving Bed System: Permanent optimum oxygen supply; self-cleaning effect of dead biomass; expertise from industrial water treatment



3

INDIVIDUAL MODULE

Flexible and highly effective. The filter system is flexibly adapted to the individual conditions of the water.

- Space-saving pump and UVC chamber for easy integration of: Aquamax Eco Gravity filter pumps and Bitron Premium UVC pre-clarifiers
- Maximum flexibility in connection with DN 110 and 2" feed-throughs
- To increase the filter performance, the two individual baskets can be fitted with additional filter medium in the flow range with a filling volume of up to 8 litres

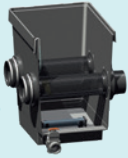
All modules incl. a high-quality DN 75 gate valve for the floor drain

				
PRODUCT	PROFICLEAR PREMIUM DF-L PUMPED	PROFICLEAR PREMIUM DF-L GRAVITY	PROFICLEAR PREMIUM MOVING BED MODULE	PROFICLEAR PREMIUM INDIVIDUAL MODULE
Dimensions (L x W x H)	830 x 600 x 820 mm	830 x 600 x 820 mm	830 x 600 x 820 mm	830 x 600 x 820 mm
Power consumption	5 W	5 W	-	-
Power consumption, cleaning	1050 W	1050 W	-	-
Cable length	5.00+ 1.00 m	5.00+ 5.00 m	-	-
Guarantee (+ request guarantee) ^{*)}	2 + 1 years	2 + 1 years	2 + 1 years	2 + 1 years
Control unit	Microcontroller	Microcontroller	-	-
Temperature display	Digital	Digital	-	-
Coarse debris extraction	60 µm	60 µm	-	-
Scavenging pump	6 bar	6 bar	-	-
Flush automation	Manual, sensor, time interval	Manual, sensor, time interval	-	-
Material	GFK Duroplast/stainless steel	GFK Duroplast/stainless steel	GFK Duroplast/stainless steel	GFK Duroplast/stainless steel
Number of inlets	2 PCS	4 PCS	2 PCS	2 PCS
Inlet connections	2 x 2" (50 mm) + Bitron	DN 110	180 mm	180 mm
Number of outlets	2	2	2 PCS	4 PCS
Outlet connections	DN 150	DN 150	DN 150	2 x 2" (50 mm) / 2 x DN 110
Flush trough connection	DN 110	DN 110	-	-
Connection to	Bitron C 72–110 W, Bitron Eco 120–240 W	Bitron Premium	AquaOxy CWS 2500–5000	Aquamax Eco Gravity, Bitron Premium
Min. flow rate	10,000 l/h	10,000 l/h	10,000 l/h	10,000 l/h
Max. flow rate (litres per hour)	25,000 l/h	33,000 l/h	33,000 l/h	33,000 l/h
Installation height above water level	40.0 cm	11.5 cm	11.5 cm	11.5 cm
Type of use	Pump system	Gravity	Gravity, pump system	Gravity, pump system
Item no. (GB Version)	47004	47006	-	-
Item no.	47003	47005	50772	50771



ProfiClear Premium XL



ProfiClear Premium XL system, **gravity fed**



ProfiClear Premium XL system, **pumped**

- **For large natural and swimming ponds up to 530 m³ and koi ponds up to 100 m³**
- **Safe:** Integrated emergency overflow for permanently safe operation (only for the pumped variant)
- **Tried-and-tested:** Mature, professional technology with over three years of development time
- **Clean:** Filtration with a filtration capacity of up to 60 µm and fully automatic self-cleaning
- **Control:** Suitable for outdoor use, the microcontroller monitors and controls the functions
- **Modern:** Modular filter system for professional water quality in confined spaces
- **Top:** Outstanding filter capacity with intelligent control functions
- **Drum filter module:** Intelligent self-cleaning function for uniquely maintenance-free operation
- **Smart:** Control all settings conveniently via app using connection options to the OASE Control System*
- **Moving Bed:** Even more effective degradation of pollutants and nutrients thanks to the high-performance filter media OASE PondPads, which work best in the Moving Bed System
- **For discerning owners of large ponds:** High degradation rates of ammonium, ammonia, nitrite and nitrate due to larger moving bed modules for up to 150 litres Hel-X and especially in combination with the OASE PondPads biofilter media
- **"Made in Germany":** Precise and reliable engineering skills with particularly high quality (except pressure pump)

* **System requirements:** A Garden Controller Cloud or InScenio FM-Master Cloud is required to use the OASE Control functions.

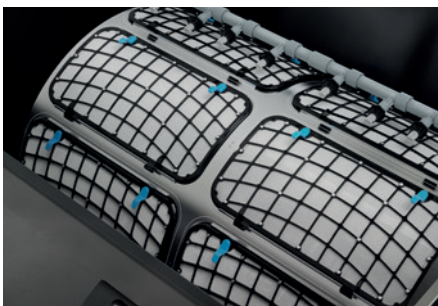

1 DRUM FILTER MODULE XL



2 MOVING BED MODULE XL

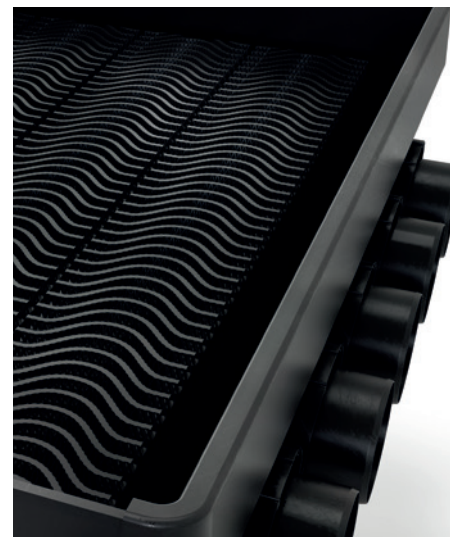

3 DRAIN MODULE XL



PRODUCT	1	1	2	3	3
	PROFICLEAR PREMIUM DF-XL PUMPED	PROFICLEAR PREMIUM DF-XL GRAVITY	PROFICLEAR PREMIUM XL MOVING BED	PROFICLEAR PREMIUM XL DRAIN MODULE, PUMPED	PROFICLEAR PREMIUM XL DRAIN MODULE, GRAVITY
Dimensions (L x W x H)	1330 x 875 x 820 mm	1330 x 875 x 820 mm	1330 x 875 x 820 mm	1330 x 875 x 820 mm	1330 x 875 x 820 mm
Power consumption	5 W	5 W	-	-	-
Power consumption, cleaning	1600 W	1600 W	-	-	-
Cable length	5.00+ 5.00 m	5.00+ 5.00 m	-	-	-
Net weight	125.00 kg	125.00 kg	-	-	-
Guarantee (+ request guarantee) <small>*p. 137</small>	2 + 1 years	2 + 1 years	2 + 1 years	2 + 1 years	2 + 1 years
Biological filter surface	-	-	5000.0 m ²	-	400.0 m ²
Protected biological filter surface	-	-	300.0 m ²	-	81.0 m ²
Control unit	Microcontroller	Microcontroller	-	-	-
Temperature display	Digital	Digital	-	-	-
Coarse debris extraction	60 µm	60 µm	-	-	-
Scavenging pump	7 bar	7 bar	-	-	-
Flush automation	Manual, sensor, time interval	Manual, sensor, time interval	-	-	-
Material	GFK Duroplast/ stainless steel	GFK Duroplast/ stainless steel	GFK Duroplast	GFK Duroplast/ stainless steel	GFK Duroplast/ stainless steel
Number of inlets	-	-	2 PCS	5 PCS	9 PCS
Inlet connections	5 PCS	7 PCS	-	-	-
Inlet connections	3 x 2" / 2 x DN 110	DN 110	180 mm	180 mm	180 mm
Number of outlets	2 PCS	2 PCS	2 PCS	5 PCS	9 PCS
Outlet connections	180 mm	180 mm	180 mm	DN 110	4 x 2" / 5 x DN 110
Flush trough connection	DN 110	DN 110	-	-	-
Connection to	Bitron Premium, ProfiClear Premium XL drain module pumped, ProfiClear Premium XL Moving Bed	Bitron Premium, ProfiClear Premium XL drain module gravity, ProfiClear Premium XL Moving Bed	AquaOxy 5000 ProfiClear Premium DF-XL pumped OC ProfiClear Premium DF-XL gravity OC ProfiClear Premium XL drain module pumped ProfiClear Premium XL drain module gravity	AquaOxy 2500, ProfiClear Premium DF-XL pumped OC ProfiClear Premium XL Moving Bed	Bitron Premium ProfiClear Premium DF-XL gravity OC ProfiClear Premium XL Moving Bed
Min. flow rate	25,000 l/h	25,000 l/h	25,000 l/h	25,000 l/h	25,000 l/h
Max. flow rate (litres per hour)	50,000 l/h	66,000 l/h	66,000 l/h	50,000 l/h	66,000 l/h
Installation height above water level	52.0 cm	13.5 cm	8.5 cm	32.0 cm	8.5 cm
Possible water level difference	-	-20 mm	-	-	-
Type of use	Pump system	Gravity	Gravity, pump system	Pump system	Gravity
Item no. (GB Version)	73366	73364	-	-	-
Item no.	73365	73363	73367	73369	73368

Selection tables

ProfiClear Premium

NATURAL PONDS AND SWIMMING PONDS 	40 m ³	70 m ³	100 m ³	150 m ³	200 m ³	300 m ³	400 m ³	500 m ³
ProfiClear Premium L	1 PC	1 PC	1 PC	–	–	–	–	–
ProfiClear Premium XL	–	–	–	1 PC	1 PC	1 PC	1 PC	1 PC
ProfiClear Premium Fleece	500	500	750	750	–	–	–	–
Moving Bed module	1 PC	2 PCS	2 PCS	–	–	–	–	–
Moving bed module XL	–	–	–	1 PC	2 PCS	2 PCS	3 PCS	3 PCS
Individual module	1 PC	1 PC	1 PC	–	–	–	–	–
Drain module XL	–	–	–	1 PC	1 PC	1 PC	1 PC	1 PC
Bitron Eco 72 W/110 W	72 W	72 W	110 W	–	–	–	–	–
Bitron Eco 120 W/180 W/240 W	–	–	120 W	180 W	240 W	–	–	–
Bitron Premium 60 W/120 W/180 W	–	–	120 W	180 W	2 x 120 W	–	2 x 180 W	3 x 180 W
Pump output/h = pond size/6								

This table already takes into account the usual flow losses within the filter system.



FISH PONDS AND SWIMMING PONDS 	20 m ³	40 m ³	50 m ³	80 m ³	100 m ³	150 m ³	200 m ³	300 m ³
ProfiClear Premium L	1 PC	1 PC	1 PC	–	–	–	–	–
ProfiClear Premium XL	–	–	–	1 PC	1 PC	1 PC	1 PC	1 PC
ProfiClear Premium Fleece	500	500	750	750	–	–	–	–
Moving Bed module	1 PC	2 PCS	2 PCS	–	–	–	–	–
Moving bed module XL	–	–	–	1 PC	2 PCS	2 PCS	3 PCS	3 PCS
Individual module	1 PC	1 PC	1 PC	–	–	–	–	–
Drain module XL	–	–	–	1 PC	1 PC	1 PC	1 PC	1 PC
Bitron Eco 72 W/110 W	72 W	72 W	110 W	110 W	–	–	–	–
Bitron Eco 120 W/180 W/240 W	–	–	120 W	120 W	180 W	240 W	–	–
Bitron Premium 60 W/120 W/180 W	60 W	60 W	120 W	120 W	180 W	60 W + 180 W	120 W + 180 W	2 x 180 W
Pump output/h = pond size/3								

This table already takes into account the usual flow losses within the filter system.

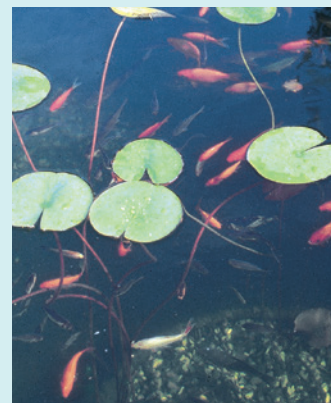

EXTRAS

Hel-X 13 Biomedica 25 l

Expansion kit for the moving bed module. Increases the biological performance. 2 x 25 l sufficient for approx. 340 g feed/day.

Item no. 42904



ProfiClear Compact/BioTec Premium sieve set 60 µm

Increases the separation performance of the drum filter for maximum water brilliance. Note: The flushing cycles and the associated water consumption increase when using this set. Content: 6 sieve elements

Item no. 43600



Drain set ProfiClear Premium pumped

With the optional outlet adapter, you can operate the ProfiClear Premium in a pumped installation even without an individual chamber.

Item no. 50949



ProfiClear Premium sieve set 150 µm

Accessories for the drum filter module. With 150 µm, it provides a slightly coarser dirt removal and therefore reduces water consumption. Ideal for use in natural ponds or swimming ponds. Content: 8 sieve elements

Item no. 50947



ProfiClear Premium Compact

To calculate the correct UVC power for your pond:

Ponds without fish stock: 1 W UVC power per m³ pond content
 Ponds with fish stock: 2 W UVC power per m³ pond content
 Ponds with koi stock: 4 W UVC power per m³ pond content

Note: To keep the bacterial levels low in the koi pond, adhere to the recommend flow rate for the Bitron Premium range. Aim to achieve a circulation of at least 55% of the pond volume/hour.

NATURAL PONDS
(without fish stock)



	40 m ³	60 m ³	80 m ³	100 m ³	120 m ³	140 m ³
ProfiClear Premium Compact M	1 PC	1 PC	1 PC	–	–	–
ProfiClear pump chamber Classic/Compact	1 PC	1 PC	1 PC	–	–	–
ProfiClear Premium Compact L	–	–	1 PC	1 PC	1 PC	1 PC
ProfiClear individual module	1 PC	1 PC	1 PC	1 PC	1 PC	1 PC
Bitron 72 W	1 PC	1 PC	–	–	–	–
Bitron 110 W	–	–	1 PC	1 PC	–	–
Bitron Eco 120 W	–	–	–	–	1 PC	–
Bitron Eco 180 W	–	–	–	–	–	1 PC
Bitron Eco 240 W	–	–	–	–	–	–
Bitron Premium 60 W/120 W/180 W	60 W	60 W	60 W	120 W	120 W	120 W
Pump output/h = pond size/6						

* Dual-row configuration (the filter system must be operated in two separate filter rows). This table already takes into account the usual flow losses within the filter system.



FISH PONDS AND SWIMMING PONDS
(up to 1 kg/1000 l)



	20 m ³	30 m ³	40 m ³	50 m ³	60 m ³	70 m ³
ProfiClear Premium Compact M	1 PC	1 PC	1 PC	–	–	–
ProfiClear pump chamber Classic/Compact	1 PC	1 PC	1 PC	–	–	–
ProfiClear Premium Compact L	–	–	1 PC	1 PC	1 PC	1 PC
ProfiClear individual module	1 PC	1 PC	1 PC	1 PC	1 PC	1 PC
Bitron 72 W	1 PC	1 PC	–	–	–	–
Bitron 110 W	–	–	1 PC	1 PC	–	–
Bitron Eco 120 W	–	–	–	–	1 PC	–
Bitron Eco 180 W	–	–	–	–	–	1 PC
Bitron Eco 240 W	–	–	–	–	–	–
Bitron Premium 60 W/120 W/180 W	60 W	60 W	60 W	60 W	120 W	120 W
Pump output/h = pond size/3						

* Dual-row configuration (the filter system must be operated in two separate filter rows). This table already takes into account the usual flow losses within the filter system.

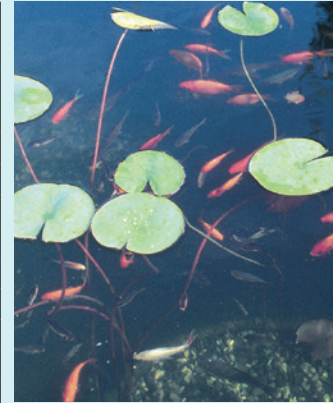

KOI PONDS



	15 m ³	20 m ³	22 m ³	30 m ³	35 m ³	75 m ³	100 m ³
ProfiClear Premium Compact M	1 PC	1 PC	1 PC (gravity)	–	–	–	–
ProfiClear Premium XL	–	–	–	–	–	1 PC	1 PC (gravity)
ProfiClear Premium Compact L	1 PC	1 PC	1 PC	1 PC	1 PC (gravity)	–	–
ProfiClear Premium Fleece	500	500	500	750	750	–	–
Moving Bed / Standing Bed	–	–	1 PC	1 PC	1 PC	1 PC/1 PC	1 PC/1 PC
Bitron 72 W	1 PC	–	–	–	–	–	–
Bitron 110 W	–	1 PC	1 PC	–	–	–	–
Bitron Eco 120 W	–	–	–	1 PC	–	–	–
Bitron Eco 180 W	–	–	–	–	1 PC	1 PC	1 PC
Bitron Premium 60 W/120 W/180 W	60 W	60 W	60 W	120 W	120 W	60 W+180 W	2x 180 W
Pump capacity/h = pond size/1.5							

* Dual-row configuration (the filter system must be operated in two separate filter rows). This table already takes into account the usual flow losses within the filter system and expert recommendations on disinfecting koi ponds.



Vitronic



- **Suitable for ponds up to 60 m³**
- **Greater clarity:** UVC irradiation destroys the cell structure of floating algae (green water), decimates harmful bacteria and germs and therefore effectively prevents their growth
- **Three inlets:** Individual options for attaching to a variety of OASE filter models (e.g. BioSmart), but also to third-party filters
- **Easy installation:** Simply attach the clarifier to the connecting hose between the pond pump and the filter
- **Easy assembly:** Extensive connection accessories, including high-quality UVC lights
- **Visibility:** Visual function check of the UVC light
- **Safe:** 100% VDE-certified safety; does not cause eye injuries
- **High quality:** Top workmanship with impact-resistant plastic housing
- **Easy:** Quick release for easy bulb replacement and for cleaning the quartz glass



Direct assembly on BioSmart: The 18–36 W Vitronic devices can also be mounted directly on the filter housing of the BioSmart and BioTec models.

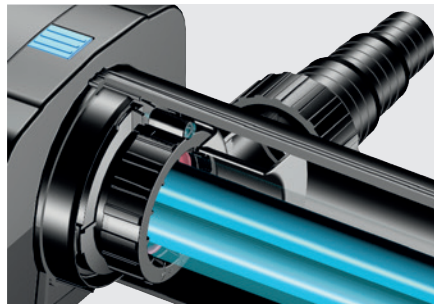

UVC lamps in the glass tube: The use of high-quality UVC lamps guarantees a long service life and consistently good irradiation performance.



Control window: To check the lamp function (not included with Vitronic 11 W).

PRODUCT	VITRONIC 11 W	VITRONIC 18 W	VITRONIC 24 W	VITRONIC 36 W	VITRONIC 55 W
Dimensions (L x W x H)	330 x 120 x 100 mm	529 x 186 x 130 mm	529 x 186 x 130 mm	529 x 186 x 130 mm	660 x 155 x 130 mm
Power consumption	14 W	18 W	24 W	36 W	55 W
Power cable length	3.00 m	5.00 m	5.00 m	5.00 m	5.00 m
Warranty^{*p-131}	2 years	2 years	2 years	2 years	2 years
UVC power	11 W	18 W	24 W	36 W	55 W
Inlet connections	19/25/32/38 mm (¾", 1", 1 ¼", 1 ½")	25/32/38 mm (1", 1 ¼", 1 ½")			
Outlet connections	19/25/32/38 mm (¾", 1", 1 ¼", 1 ½")	25/32/38 mm (1", 1 ¼", 1 ½")			
Max. flow rate (litres per hour)	1700 l/h	3500 l/h	4500 l/h	6000 l/h	8500 l/h
Suitable for ponds up to max.	10.0 m ³	20.0 m ³	25.0 m ³	40.0 m ³	60.0 m ³
Suitable for ponds with fish stock	5.0 m ³	10.0 m ³	12.5 m ³	20.0 m ³	30.0 m ³
Suitable for ponds with koi[†]	2.5 m ³	5.0 m ³	6.5 m ³	10.0 m ³	15.0 m ³
Connection to	–	BioSmart 18000/36000, BioTec ScreenMatic ² 40000–60000			–
Item no. (GB Version)	–	–	–	–	–
Item no.	88108	56837	56869	56885	57373

*1 Note: When planning new ponds with koi stock, please observe a minimum size of 5 m³!

UVC CLARIFIER WITH PATENTED SELF-CLEANING AND BYPASS TECHNOLOGY

Bitron C



- **Suitable for ponds up to 110 m³**
- **Greater clarity:** UVC irradiation destroys the cell structure of floating algae (green water), decimates harmful bacteria and germs
- **Self-cleaning:** Highly effective UV radiation at all times thanks to patented, independent lamp cleaning
- **Automatic:** Due to the water flow, the cleaning rotor is continuously and automatically guided around the quartz glass tube and therefore prevents dirt deposits
- **Quick-release closure:** For easy opening of the lamp housing. To protect against eye damage, a safety switch automatically deactivates the UVC lamp
- **Safe:** 100% protection against eye damage
- **Included:** High-quality UVC lights
- **Quality:** High-quality design with impact-resistant plastic
- **Eye-catching:** Visual function check of the UVC light
- **Guaranteed:** Includes OASE clear water guarantee (in conjunction with the OASE flow-through filters BioSmart, BioTec and ProfiClear)
- **Synchronous:** Individual regulation of the water flow rate allows you to optimally tune the Bitron C to the connected filter pump
- **Integrated:** Magnets for protecting the filter equipment from lime deposits

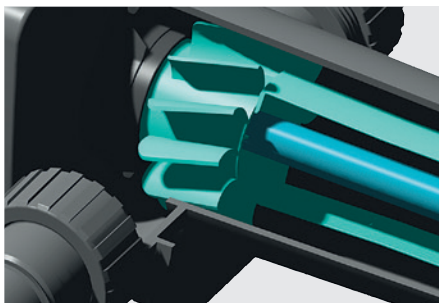

Automatic cleaning rotor: Due to the water flow, the cleaning rotor is continuously guided around the quartz glass tube and therefore prevents dirt deposits.

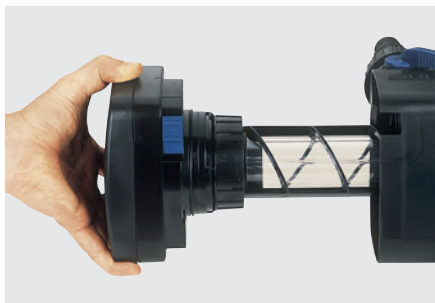

Closure technology: Quick-release closure for easy opening of the lamp housing. A safety switch automatically deactivates the UVC lamp to protect against eye damage.



Throttle twist handle: For customisable regulation of the water flow rate.

PRODUCT	BITRON C 24 W	BITRON C 36 W	BITRON C 55 W	BITRON C 72 W	BITRON C 110 W
Dimensions (L x W x H)	440 x 180 x 198 mm	600 x 180 x 198 mm		730 x 215 x 200 mm	
Power consumption	24 W	36 W	55 W	72 W	110 W
Power cable length	5.00 m	5.00 m	5.00 m	5.00 m	5.00 m
Warranty^{*1}	2 years	2 years	2 years	2 years	2 years
UVC power	24 W	36 W	55 W	72 W	110 W
Inlet connections	1 PC	1 PC	1 PC	1 PC	1 PC
Inlet connections	25/32/38 mm (1", 1 1/4", 1 1/2")	25/32/38 mm (1", 1 1/4", 1 1/2")	19/25/32/38/50 (3/4", 1", 1 1/4", 1 1/2", 2")		
Min. flow rate	4000 l/h	8000 l/h	8000 l/h	12,000 l/h	12,000 l/h
Max. flow rate (litres per hour)	15000 l/h	30000 l/h	30000 l/h	40000 l/h	40000 l/h
Suitable for ponds up to max.	25.0 m ³	40.0 m ³	60.0 m ³	75.0 m ³	110.0 m ³
Suitable for ponds with fish stock	12.5 m ³	20.0 m ³	30.0 m ³	37.5 m ³	55.0 m ³
Suitable for ponds with koi^{*1}	6.5 m ³	10.0 m ³	15.0 m ³	19.0 m ³	27.5 m ³
Connection to	BioSmart 18000/36000	BioSmart 18000/36000, BioTec ScreenMatic ² 40000-60000		Biotec 30, BioTec ScreenMatic ² 90000-145000, ProfiClear	
Item no. (GB Version)	-	-	-	-	-
Item no.	56804	56799	56823	56901	56902

^{*1}Note: When planning new ponds with koi stock, please observe a minimum size of 5 m³!

HIGHLY EFFICIENT UVC CLARIFIER

Bitron Eco



- **Concentrated UVC power clarifies ponds up to 240 m³**
- **Feasible:** Easy connection to other 2" filter systems
- **Guaranteed:** Includes OASE clear water guarantee (in conjunction with the OASE flow-through filters BioSmart, BioTec and ProfiClear)
- **New:** Large-volume UVC housing with new design and organic shape, for a particularly long retention time and treatment of the water
- **Bypass:** The integrated bypass membrane regulates the water distribution fully automatically based on the water flow and adapts to changing conditions such as the Seasonal Flow Control System
- **Automatic:** The control unit not only automatically shows you the current status of your lamps and the water temperature, it also allows you to adjust the output according to your needs
- **Climate protection:** The eco mode saves up to 525 kg CO₂/year*2
- **Up to 50% less:** The eco control system enables maximum energy efficiency with such a high savings potential
- **Any time:** Fully effective UVC radiation thanks to patented automatic cleaning of the UV lamp
- **Effective:** Very intensive treatment of floating algae, turbidity and harmful bacteria in pond water
- **Safe:** 100% protection against eye damage



Direct assembly: on the ProfiClear Premium Compact M.



Automatic control unit: The control unit not only shows the current status of your lamps and the water temperature, it also allows you to adjust the output to suit your needs.



Automatic bypass regulation: The integrated bypass membrane regulates the water distribution fully automatically based on the water flow and adapts to changing conditions such as the Seasonal Flow Control System.

PRODUCT	BITRON ECO 120 W	BITRON ECO 180 W	BITRON ECO 240 W
Dimensions (L x W x H)	725 x 227 x 248 mm	725 x 227 x 248 mm	725 x 227 x 248 mm
Power consumption	120 W	180 W	240 W
Power cable length	5.00 m	5.00 m	5.00 m
Guarantee (+ request guarantee)*p-131	2 + 1 years	2 + 1 years	2 + 1 years
UVC power	120 W	180 W	240 W
Number of inlets	1 PC	1 PC	1 PC
Inlet connections	38/50 mm (1 1/2", 2")	38/50 mm (1 1/2", 2")	38/50 mm (1 1/2", 2")
Outlet connections	38/50 mm (1 1/2", 2")	38/50 mm (1 1/2", 2")	38/50 mm (1 1/2", 2")
Max. flow rate (litres per hour)	50,000 l/h	50,000 l/h	50,000 l/h
Max. operating pressure	1 bar	1 bar	1 bar
Suitable for ponds up to max.	120.0 m ³	180.0 m ³	240.0 m ³
Suitable for ponds with fish stock	60.0 m ³	90.0 m ³	120.0 m ³
Suitable for ponds with koi ¹²	30.0 m ³	45.0 m ³	60.0 m ³
Connection to	Biotec 30, BioTec ScreenMatic ² 90000-145000, ProfiClear	Biotec 30, BioTec ScreenMatic ² 145000, ProfiClear	
Item no. (GB Version)	-	-	-
Item no.	56769	56405	56410

HIGHLY EFFICIENT – PERFECT FOR BOTH PUMPED AND GRAVITY FILTER INSTALLATIONS

Bitron Premium



- **Suitable for ponds up to 280 m³**
- **Cleaners:** Extremely effective elimination of algae and pathogenic bacteria; works in the same way as an immersion UVC
- **Guaranteed:** Clear water guarantee when used in conjunction with OASE ProfiClear filters
- **Safe:** 100% protection against eye damage
- **Highly effective:** Exceptionally effective sterilisation thanks to the extra-long retention time of the water in the Bitron
- **Perfected:** The flow-optimised reactor design ensures direct and almost loss-free UV radiation
- **Optional:** Horizontal or vertical installation
- **Flexible:** Can be connected either upstream or downstream of the ProfiClear filter system – also applies to other gravity applications
- **Expandable:** If you enlarge the size of your pond or increase the amount of fish stock, additional Bitron Premium UVC devices can be incorporated with ease
- **Check:** Visual function check
- **Simple:** Particularly straightforward installation using stainless-steel fasteners



Highly efficient: Perfect for both pumped and gravity filter systems.



Drain module gravity XL: Enlarged pump and UVC chamber for easy integration of AquaMax Eco Expert and AquaMax Eco Titanium filter pumps as well as the new Bitron Premium UVC pre-clarifiers.

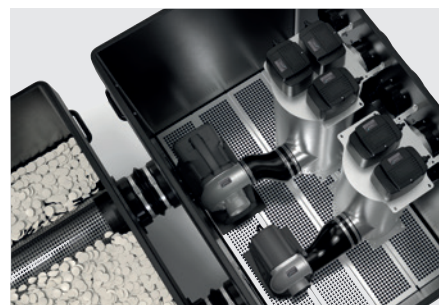

Pump chamber: Can be optimally integrated into the ProfiClear Premium System.

PRODUCT	BITRON PREMIUM 60 W	BITRON PREMIUM 120 W	BITRON PREMIUM 180 W
Dimensions (L x W x H)	700 x 290 x 205 mm	700 x 387 x 305 mm	700 x 417 x 340 mm
Power cable length	5.00 m	7.00 m	7.00 m
Warranty ^{*p-131}	2 years	2 years	2 years
UVC power	60 W	120 W	180 W
Inlet connections	DN 110	DN 110	DN 110
Outlet connections	DN 110	DN 110	DN 110
Max. flow rate (litres per hour)	40000 l/h	70,000 l/h	100,000 l/h
Rec. flow rate (gravitation)	16,500 l/h	33,000 l/h	50,000 l/h
Suitable for ponds up to max.	90.0 m ³	185.0 m ³	280.0 m ³
Suitable for ponds with fish stock	50.0 m ³	100.0 m ³	160.0 m ³
Suitable for ponds with koi [†]	33.0 m ³	66.0 m ³	100.0 m ³
Connection to	AquaMax, ProfiClear		
Type of use	Gravity, pump system		
Item no. (GB Version)	-	-	-
Item no.	73374	73375	73376

AquaOxy



Compact design, powerful result:

Despite high performance, the models are handy and can be stored in the filter chamber or outdoors next to the pond in a space-saving way.



Optimal accessories: For an even more optimal supply, the ventilation rod and the ventilation ring convert the generated fresh air volume flow in the water into thousands of the finest air bubbles.

- **Suitable for ponds up to 50 m³ or with high fish stock**
- **Extremely quiet:** The precise airflow (2500 to 7500 l/h depending on the model) ensures that the device operates extremely quietly
- **Suitable adapter:** The standardised air outlet allows easy connection to any individual area on site
- **Top-quality motor:** Reliability – that is what this powerful, durable, quiet, economical and energy-efficient premium-class unit promises
- **New metal housing:** The robust and high-quality housing is splash-proof all around (IP44 degree of protection)
- **UV stable:** The plastic housing protects the air pumps from splashing water and allows them to be installed outdoors
- **Incl. accessories:** Air stones are included in the scope of delivery of the AquaOxy models 250–1000

From AquaOxy 1000

- Wear-free air stones
- Infinitely adjustable air flow rate

From AquaOxy 2500

- Finished with high-quality metal housing
- Can be used as ice preventer

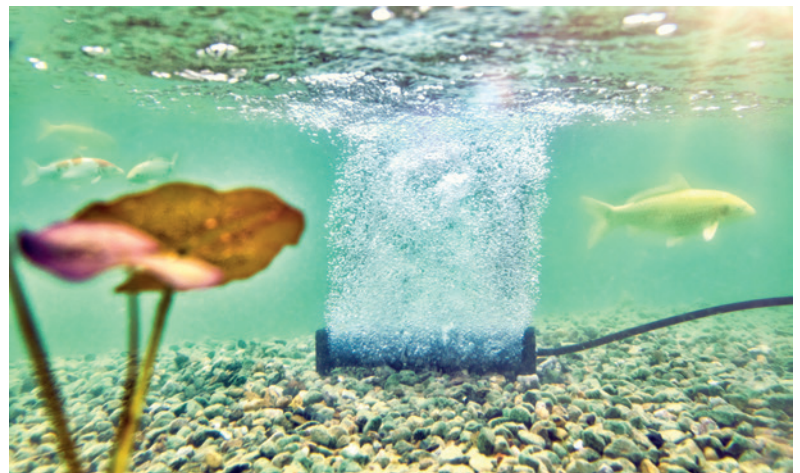

PRODUCT	AQUAOXY 250	AQUAOXY 500	AQUAOXY 1000	AQUAOXY 2500	AQUAOXY 5000	AQUAOXY 7500
Dimensions (L x W x H)	167 x 106 x 75 mm	185 x 140 x 110 mm	220 x 225 x 135 mm	245 x 185 x 200 mm	255 x 190 x 210 mm	260 x 195 x 220 mm
Rated voltage (primary, secondary)	–	–	230 V/50 Hz, 12 V/AC	–	–	–
Rated voltage	230 V / 50 Hz	230 V / 50 Hz	–	220–240 V/50 Hz	220–240 V/50 Hz	220–240 V/50/60 Hz
Power consumption	4 W	8 W	15 W	40 W	75 W	125 W
Power cable length	3.00 m	3.00 m	3.00 m	3.00 m	5.00 m	5.00 m
Warranty¹⁾ 131	2 years	2 years	2 years	2 years	2 years	2 years
Max. flow rate (litres per hour)	250 l/h	500 l/h	1000 l/h	2500 l/h	5000 l/h	7500 l/h
Pressure	0.15/1.50 bar	0.2/2.00 bar	0.2/2.00 bar	–	–	–
Mechanically adjustable	No	No	Yes	Yes	Yes	Yes
Hose (quantity/length/diameter)	1 PC/10 m/4.5 mm	2 PCS/5 m/4.5 mm	2 PCS/5 m/4.5 mm	–	–	–
Number of outlets	1 PC	1 PC	2 PCS	1 PC	1 PC	1 PC
Suitable for ponds up to max.	3.0 m ³	5.0 m ³	10.0 m ³	25.0 m ³	50.0 m ³	75.0 m ³
Outdoor suitability	Unrestricted	Unrestricted	Unrestricted	Unrestricted	Unrestricted	Unrestricted
Number of air stones	1 PC	2 PCS	2 PCS	0 PCS	0 PCS	0 PCS
Item no. (GB Version)	73377	57567	–	87103	87104	87105
Item no.	34064	57063	37125	87100	87101	87102

PROVEN VENTILATION SYSTEM FOR THE POND

OxyTex sets



- **Standard OASE:** Unique combination of oxygen supply, water circulation and nutrient breakdown
- **Single:** The OxyTex – as a single product for already installed air pumps (including adapter for 9 mm hoses)
- **Ready to connect:** Ready-to-connect complete sets with AquaOxy and OxyTex air pump
- **Filter plus:** As an ideal supplement to FiltoMatic CWS and FiltoClear, the overall filter performance can be increased by up to 25%
- **Miraculously spacious:** Lots of space for microorganisms thanks to the area-optimised fibre structure
- **OASE expertise:** Patented technology
- **Attractive:** Pretty design in a plant-like look



PRODUCT	OXYTEX 400	OXYTEX 1000	OXYTEX SET 500	OXYTEX SET 1000
Dimensions (Ø x H)	144 x 290 mm	220 x 300 mm	144 x 290 mm	220 x 300 mm
Rated voltage (primary, secondary)	–	–	–	230 V/50 HZ, 12 V/AC
Rated voltage	–	–	230 V / 50 Hz	–
Power consumption	–	–	8 W	15 W
Power cable length	–	–	3.00 m	2.00 m (power supply unit) + 3.00 m
Warranty ^{*p-131}	2 years	2 years	2 years	2 years
Biological filter surface	1.5 m ²	3.5 m ²	1.5 m ²	3.5 m ²
Max. operating pressure	0.4 bar	0.4 bar	0.4 bar	0.4 bar
Max. pump output	500 m ³	1000 m ³	500 m ³	1000 m ³
Hose (quantity/length/diameter)	1 PC/5 m/4.5 mm	1 PC/5 m/4.5 mm	2 PCS/5 m/4.5 mm	2 PCS/5 m/4.5 mm
Increase in filter performance	Up to 10%	Up to 25%	Up to 10%	Up to 25%
Other	1 OxyTex incl. 9 mm adapter		1 OxyTex	1 OxyTex
Item no. (GB Version)	Not available in GB			
Item no.	50443	50290	57071	50249

ICE PREVENTER AND WATER FEATURE IN ONE DEVICE

IceFree 4 Seasons

- **Summer operation:** In summer, it is ideal for use as a water feature
- **Effective airflow:** Brings oxygen into the water and releases harmful digester gases
- **Cosy:** Maintains the warm temperature zones at the bottom
- **Submerged:** Extremely energy-efficient pump technology without additional heating element (requires depth of at least 80 cm)
- **Fish-friendly:** An ice-free area is created around the floating body down to -20°C



EXTRAS

RECOMMENDATION
 For the IceFree to function reliably, a minimum water depth of 80 cm is recommended.

PRODUCT	ICEFREE FOUR SEASONS
Dimensions (L x W x H)	200 x 160 x 840 mm
Rated voltage	230 V / 50 Hz
Power consumption	5 W
Power cable length	10.00 m
Warranty ^{p. 131}	2 years
Max. flow rate	7 l/min
Max. head height, metres	0.75 m
Frost monitor function	No
Item no. (GB Version)	Not available in GB
Item no.	49992

KEEPS YOUR POND SAFE OVER WINTER

IceFree Thermo



- **Small pond:** Due to an active heating element it is also suitable for shallow ponds and permanently cold frost periods
- **Effective airflow:** Brings oxygen into the water and releases harmful digester gases
- **Cosy:** Maintains the warm temperature zones at the bottom
- **Fish-friendly:** An ice-free area is created around the floating body down to -20°C
- **Frost monitor:** IceFree Thermo 330 has a frost-monitoring function. Because it only starts when there is a risk of frost, you do not pay for energy consumption on warmer days
- **Performance plus:** Clever resistance heating technology, for higher performance in the freezing range and protection against temperature damage in the air



EXTRAS

RECOMMENDATION

The IceFree 330 is particularly energy-saving. Thanks to the frost monitor function, it only activates when there is a real risk of frost on the water surface.

PRODUCT	ICEFREE THERMO 330
Dimensions (L x W x H)	300 x 135 x 334 mm
Rated voltage	220-240 V/50 Hz
Power consumption	330 W
Power cable length	10.00 m
Warranty ¹⁰⁻¹³¹	2 years
Frost monitor function	Yes
Item no. (GB Version)	Not available in GB
Item no.	51231

A photograph of a pond in a garden. In the foreground, there are several purple lavender flowers. A black cleaning tool is visible in the water, creating ripples. The background shows lush greenery and a bright sky with clouds and a sun flare.

Cleaning and skimmers



Further information
is available at:
[www.oase.com/en/
skimmers-cleaning](http://www.oase.com/en/skimmers-cleaning)

62 Surface skimmer

- 62 **SWIMSKIM**
- 62 **AQUASKIM**
- 63 **BIOSYS SKIMMER +**
- 63 **PROFISKIM**

64 Pond vacuums and pool vacuums

- 64 **PONDOVAC CLASSIC**
- 64 **PONDOVAC 3**
- 65 **PONDOVAC 4**
- 66 **PONDOVAC 5**

67 Pond care

- 67 **USEFUL POND AIDS**

FLOATING FOR CLEAR WATER SURFACES

SwimSkim

- **Superskimmer:** Effectively skims pond surfaces of up to 50 m²
- **Automatic:** Adapts to any water level from a depth of 40 cm
- **Venturi function:** Prevents sediment at the bottom of the pond
- **Low consumption:** Particularly energy-saving eco motor technology
- **OASE expertise:** Particularly effective suction performance thanks to patented hinge technology
- **Deep view:** Removes dirt directly on the surface – experience significantly better water quality and deeper visibility
- **Injector:** For better oxygen supply to the pond



PRODUCT	SWIMSKIM 25	SWIMSKIM 50
Dimensions (L x W x H)	332 x 297 x 263 mm	450 x 400 x 390 mm
Rated voltage	220–240 V/50 Hz	220–240 V/50 Hz
Power consumption	40 W	45 W
Power cable length	10.00 m	10.00 m
Filter volume	0.9 l	4.5 l
Max. pump output	2500 l/h	3500 l/h
Max. pond surface area	25 m ²	50 m ²
Venturi function	No	Yes
Item no. (GB Version)	50124	-
Item no.	57384	50170

VARIABLE STANDING AND GRAVITY-FED SKIMMER

AquaSkim

- **Superskimmer:** Effectively skims pond surfaces of up to 50 m²
- **Ideal:** Perfectly suited to working in conjunction with all AquaMax Eco Premium filter and watercourse pumps
- **Compatible:** The AquaSkim Gravity – with high-quality DN 160/110 adapter, for easy integration into DN 110 line systems
- **Nice and easy:** The easily accessible coarse dirt basket makes device maintenance a breeze
- **Hands on:** The dirt basket can be removed even from a distance thanks to the practical grip hooks
- **Perfect:** Ideally, run the AquaSkim 20 with the AquaMax Eco Premium 5000–9000 pump
- **Deep view:** Removes dirt directly on the surface – experience significantly better water quality and deeper visibility
- **Stability:** Fill the large tray on the stand with stones to weigh it down



PRODUCT	AQUASKIM 20	AQUASKIM 40	AQUASKIM GRAVITY
Dimensions (Ø x H)	350 x 800 mm	350 x 800 mm	170 x 260 mm
Height adjustment	370–850 mm	380–880 mm	-
Filter volume	1.2 l	1.4 l	1.4 l
Possible water level difference	100 mm	120 mm	120 mm
Min. pump capacity	4000 l/h	8000 l/h	8000 l/h
Max. pump output	8000 l/h	20,000 l/h	20,000 l/h
Max. pond surface area	20 m ²	40 m ²	40 m ²
Outlet connections	25/32/38 mm (1", 1 ¼", 1 ½")	25/32/38 mm (1", 1 ¼", 1 ½")	DN 110
Item no. (GB Version)	-	-	-
Item no.	51236	56907	51237

SKIMMER FOR INSTALLATION AT THE POND EDGE

BioSys Skimmer +



- **Superskimmer:** Effectively skims pond surfaces of up to 50 m²
- **Best choice:** For operation with the optionally available AquaMax Eco filter pumps (in the integrated pump vault)
- **Firmly fixed:** Install the skimmer directly on the edge of the pond, firmly in the soil
- **Simple:** Simply flange the skimmer onto the pond liner
- **Convenient:** Coarse dirt is particularly easy to remove
- **Included:** The cover in natural-looking stone
- **Adjustment** The skimmer independently adapts to fluctuations in water level up to 100 mm

PRODUCT

BIOSYS SKIMMER +

Dimensions (L x W x H)	580 x 400 x 450 mm
Possible water level difference	100 mm
Filter volume	12 l
Max. pond surface area	50 m ²
Min./max. pump capacity	6000/16,000 l/h
Outlet connections	25/32/38 mm (1", 1 1/4", 1 1/2")
Item no. (GB Version)	-
Item no.	57137

THE PROFESSIONAL FOR SHALLOW WATER ZONES

ProfiSkim/ProfiSkim Wall

- **Add-on:** Perfect supplement for gravity or pumped filter systems
- **Amphibian protection:** Due to low flow speed at the overflow edge (only for the ProfiSkim 100)
- **Firmly fixed:** Stable base made of stainless steel
- **You choose:** Can be used in either gravity (DN 110) or pumped operation (includes 2" adapter [50 mm])
- **Ideal:** For use in the shallow water zone
- **Effective:** Optimal water supply ensures enormous suction power
- **Easy clean:** Large, easy-to-clean stainless-steel basket with 8 mm mesh width (ProfiSkim 100 + Premium)



PRODUCT

PROFISKIM WALL

PROFISKIM 100

PROFISKIM PREMIUM

Dimensions (L x W x H)/(L x W)	273 x 267 x 408 mm	780 x 585 mm	500 x 340 mm
Height adjustment	-	350-550 mm	350-550 mm
Outlet connections	DN 110	50 mm (2"), DN 110	50 mm (2"), DN 110
Rec. Flow rate (pumped)	-	10,000-20,000 l/h	6000-16,000 l/h
Rec. Flow rate (gravity)	12,000 l/h	10,000-12,000 l/h	6000-12,000 l/h
Filter volume	-	12 l	7 l
Max. pond surface area	30 m ²	80 m ²	65 m ²
Item no. (GB Version)	-	-	Not available in GB
Item no.	70895	57134	51185

TIP

It is best to include the ProfiSkim Wall during the planning stage of the pond construction. This is much easier than retrofitting.

PondoVac Classic



- **1400 watts:** Effective sludge removal thanks to powerful 1400 W motor
- **Depth penetration:** Achieves a maximum suction depth of 2 m
- **High suction:** Achieves up to 3000 l/h, depending on the operating conditions
- **Smart:** Fully automatic activation and emptying thanks to intelligent motor electronics
- **Control:** The transparent suction tube lets you keep an eye on the flow at all times
- **Design:** Compact and with a 27 litre dirty water tank

PRODUCT	PONDOVAC CLASSIC
Dimensions (L x W x H)	370 x 370 x 580 mm
Power consumption	1400 W
Power cable length	4.00 m
Warranty ^{pp.131}	2 years
Max. suction depth	2.00 m
Max. flow rate (litres per hour)	3000 l/h
Length of suction hose	4.00 m
Length of discharge hose	2.00 m
Item no. (GB Version)	50110
Item no.	50529

PondoVac 3



- **Move it:** Thanks to its transport wheels and adjustable handle, you can move your PondoVac 3 quickly and with little effort
- **Versatile:** You can use your PondoVac 3 to clean garden ponds, swimming pools or natural pools. Or use it as a powerful wet vacuum cleaner in your home or business premises
- **Depth penetration:** Achieves a maximum suction depth of 2.10 m with its powerful 1600 W motor
- **High suction:** Achieves up to 4000 l/h, depending on the operating conditions
- **Control:** The transparent suction tube lets you keep an eye on the flow at all times
- **Non-stop technology:** The two cylinders of the same size in the two-chamber system fill and empty simultaneously, in an alternating fashion. This enables non-stop suction

PRODUCT	PONDOVAC 3
Dimensions (L x W x H)	435 x 395 x 670 mm
Power consumption	1600 W
Power cable length	4.00 m
Guarantee (+ request guarantee) ^{pp.131}	2 + 1 years
Max. suction depth	2.10 m
Max. flow rate (litres per hour)	4000 l/h
Length of suction hose	4.00 m
Length of discharge hose	2.50 m
Item no. (GB Version)	37148
Item no.	37102

POWERFUL POND AND POOL VACUUMS – WITHOUT IRRITATING INTERRUPTIONS

PondoVac 4

- **Non-stop technology:** The two cylinders of the same size in the two-chamber system fill and empty simultaneously, in an alternating fashion. This enables non-stop suction
- **Versatile:** You can use your PondoVac 4 to clean garden ponds, swimming pools or natural pools. Or use it as a powerful wet vacuum cleaner for your home or business premises
- **Manual:** With hand-held controls for regulating the suction power
- **Control:** The transparent suction tube lets you keep an eye on the flow at all times
- **Depth penetration:** Achieves a maximum suction depth of 2.40 m with its powerful 1700 W motor with optimised blade geometry
- **Move it:** With its transport wheels and adjustable handle, you can move your PondoVac quickly and with little effort
- **High suction:** Achieves up to 5000 l/h, depending on operating conditions



EXTRAS

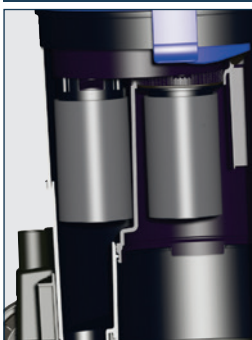

TWO-CHAMBER SYSTEM

Two cylinders of the same size are alternately filled and emptied at the same time, therefore enabling continuous vacuuming.

PRODUCT

PONDOVAC 4

Dimensions (L x W x H)	435 x 395 x 670 mm
Power consumption	1700 W
Power cable length	4.00 m
Guarantee (+ request guarantee) ^{2p-131}	2 + 1 years
Max. suction depth	2.40 m
Max. flow rate (litres per hour)	5000 l/h
Length of suction hose	5.00 m
Length of discharge hose	2.50 m
Item no. (GB Version)	42939
Item no.	50388

AMBITIOUS POND AND POOL VACUUM WITH INTEGRATED FEED PUMP

PondoVac 5

- **Flexible:** Drain away any amount of dirty water
- **Double equipped:** The drain hose has a C-connection on both sides
- **Non-stop technology:** With an integrated drainage pump for non-stop suction
- **Manual:** With hand-held controls for regulating the suction power
- **Versatile:** You can use your PondoVac 5 to clean garden ponds, swimming pools or natural pools. Or use it as a powerful wet vacuum cleaner in your home or business premises
- **Depth penetration:** The PondoVac 5 achieves a maximum suction depth of 2.50 m with its powerful 1700 W motor with optimised blade geometry
- **Control:** The transparent suction tube lets you keep an eye on the flow at all times
- **Suction monster:** Depending on the conditions of use it can achieve a suction capacity of up to 8000 l/h
- **Goodbye waste water!** Pumps out waste water even at different heights
- **Big wheel design:** More ground clearance, noise-reducing tyres included
- **Move it:** With its transport wheels and adjustable handle, you can move your PondoVac quickly and with little effort



TIP

FOR THE HIGHEST DEMANDS: PONDOVAC PREMIUM

The professional vacuum cleaner for ponds, pools, swimming ponds and households with extremely strong suction power.



EXTRAS

ACCESSORIES

Telescopic pole PondoVac
Item no. 40303

Floating hose set PondoVac 5
Set consists of 10 m, Ø 38 mm floating hose and adapter for using the nozzle attachments included in the delivery.
Item no. 41984



PRODUCT	PONDOVAC 5
Dimensions (L x W x H)	436 x 425 x 716 mm
Power consumption	1700 W
Pump power consumption	900 W
Power cable length	7.50 m
Guarantee (+ request guarantee) ^{*)-131}	2 + 1 years
Max. suction depth	2.50 m
Max. flow rate (litres per hour)	8000 l/h
Length of suction hose	5.00 m
Length of discharge hose	8.00 m
Item no. (GB Version)	41983
Item no.	41982

FOR RELAXED WORK IN AND AROUND THE GARDEN POND

Useful pond aids

AQUANET POND NETS

Protects the pond from leaves in autumn

- Prevents sludge from building up at the bottom of the pond and fermentation gases from forming due to falling branches and leaves
- Weather-resistant and robust net with 20 mm mesh width
- Includes pegs for attachment
- Available in sizes 3 x 4 m, 4 x 8 m and 6 x 10 m

AquaNet pond net 1, 3 x 4 m

Item no. 53751

Not available in GB

AquaNet pond net 2, 4 x 8 m

Item no. 53752

Not available in GB

AquaNet pond net 3, 6 x 10 m

Item no. 53753

Not available in GB



Professional pond net



Algae nets

DIPPING NETS

For work on the garden pond

- Various fishnets from a mesh size of 6 mm for releasing and catching fish
- Fine-meshed pond and algae nets for effortlessly removing fine algae and plant residues (from a mesh size of 0.3 mm)
- Professional pond and fish nets with telescopic handle and a total length of up to 2.3 m
- Easy to use thanks to the handles
- Made from anodised aluminium

Fishing nets small/large

Item no. 36300

Item no. 36299

Pond net folding

Item no. 84296

Pond net rectangular

Item no. 84297

Pond net triangular

Item no. 84308

Pond net round extra large

Item no. 84310

Professional pond net (incl. 1 spare net)

Item no. 50078

Spare net (single)

Item no. 50961

Algae nets small/large

Item no. 36298

Item no. 36297

Algae net extra fine triangular

Item no. 84318

POND GRABBERS/POND SHEARS

Pond cleaning without getting your hands dirty

- EasyPick premium telescopic pond tongs for gripping and removing cut material or leaves in and around the pond
- Shears for cutting work in and around the garden pond
- Tongs for removing foreign bodies and plant residues from the garden pond
- The clever item for fast and comfortable work: The 1.6 m long FlexiCut 2 in 1 cuts while remaining steady. The adjustable head protects the pond liner from cuts and allows convenient working
- FlexiCut shear head available as spare part from OASE (item no. 51272)

EasyPick

Item no. 40291

FlexiCut 2 in 1

Item no. 51243

Not available in GB

Replacement shear head

Item no. 51272

Not available in GB



AquaNet pond net



Pond net round extra large



Pond net triangular



Food

DYNAMIX[®]

Vital power for your fish.



Further information
is available at:
[www.oase.com/en/
dynamix](http://www.oase.com/en/dynamix)

71 Development food

71 **DYNAMIX FLAKES**

72 Standard food

72 **DYNAMIX STICKS VITAL**

72 **DYNAMIX STICKS COLOUR**

73 Mixed fish stock

73 **DYNAMIX STICKS MIX**

73 **DYNAMIX STICKS MIX + SNACK**

74 **DYNAMIX SUPER MIX**

75 Koi food

75 **DYNAMIX KOI PELLETS SMALL**

75 **DYNAMIX KOI PELLETS LARGE**

The DYNAMIX triple effect

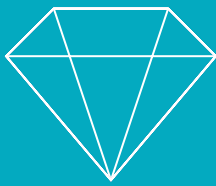

EFFECT NO. 1:

Uniform growth and intense colours

- An indispensable component of fish nutrition are fats that ensure uniform growth. If fish don't get enough fat, they use carbohydrates instead – but these are more difficult to digest and are stored as unattractive subcutaneous fat.
- OASE DYNAMIX therefore contains essential omega-3 fatty acids for uniform body growth. These are complemented by selected carbohydrate sources such as aquatic protein or red rice, which fish can easily digest.
- Dyes and aquatic pigments provide further important building blocks for intensive colour development.



EFFECT NO. 2:

Balanced intestinal flora

- Bacteria that cause disease can be stored in the intestinal walls and hinder a balanced metabolism due to toxins.
- That's why DYNAMIX contains dietary fibre that only supports the growth of positive intestinal bacteria.
- The result: The prebiotic properties of the feed complex support a balanced intestinal flora.

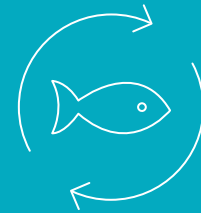

EFFECT NO. 3:

Efficient metabolism

- Essential amino acids are the key to complete food utilisation. It is only when enough of these amino acids are available that fish can make optimal use of proteins and benefit from the nutrients.
- Undigested proteins lead to ammonium being released in the water, therefore compromising the water quality – this can even lead to fish suffering from nitrogen poisoning.
- That's why DYNAMIX contains OASE AminoBoost. This active component ensures that the rich nutritional supply of DYNAMIX is utilised almost completely.



Further information is available at:
www.oase.com/en/dynamix

DELICATE FLAKES FOR UNIFORM GROWTH AND OPTIMAL DEVELOPMENT OF SMALL AND YOUNG FISH

DYNAMIX Flakes

- **Fish target group:** For feeding small and young fish
 - **Light food:** The delicate flakes quickly soften in the water, making them easy for the fish to take in with their small mouths and then digest
 - **Optimal growth:** Rich in essential omega-3 fatty acids from salmon oil
- **DYNAMIX effects no. 1–3:** see page 70



PRODUCT	DYNAMIX FLAKES 1 L
Net weight	100 g
Suitable for freshwater	Yes
Suitable for saltwater	No
Item no.	88683



IMPROVED VITAMIN INTAKE

DYNAMIX Sticks Vital

- **Fish target group:** Suitable for all ornamental fish in the pond, especially those with natural pigmentation
- **The food with pep:** Pepper has prebiotic properties, which improves a fish's ability to absorb vitamins
- **DYNAMIX effects no. 1–3:** see page 70



PRODUCT	DYNAMIX STICKS VITAL 4 L	DYNAMIX STICKS VITAL 8 L	DYNAMIX STICKS VITAL 20 L
Net weight	480 g	960 g	2400 g
Suitable for freshwater	Yes	Yes	Yes
Suitable for saltwater	No	No	No
Item no.	88679	88691	88699

AQUATIC PIGMENTS FOR RED PIGMENTATION

DYNAMIX Sticks Colour

- **Fish target group:** Suitable for all ornamental fish in the pond, especially those with red pigmentation
- **Intensity:** Aquatic pigments are used by fish for their own colour development
- **DYNAMIX effects no. 1–3:** see page 70



PRODUCT	DYNAMIX STICKS COLOUR 4 L	DYNAMIX STICKS COLOUR 8 L	DYNAMIX STICKS COLOUR 20 L
Net weight	480 g	960 g	2400 g
Suitable for freshwater	Yes	Yes	Yes
Suitable for saltwater	No	No	No
Item no.	88682	88693	88701

RICH IN VITAMINS AND WITH AQUATIC PIGMENTS FOR RED PIGMENTATION

DYNAMIX Sticks Mix

- **Fish target group:** Suitable for all ornamental fish, suitable for mixed ponds containing species with natural or red pigmentation
 - **The food with pep:** Pepper has prebiotic properties, which improves a fish's ability to absorb vitamins
 - **Intensity:** Aquatic pigments are used by fish for their own colour development
- **DYNAMIX effects no. 1–3:** see page 70



PRODUCT	DYNAMIX STICKS MIX 1 L	DYNAMIX STICKS MIX 4 L	DYNAMIX STICKS MIX 8 L	DYNAMIX STICKS MIX 20 L
Net weight	120 g	480 g	960 g	2400 g
Suitable for freshwater	Yes	Yes	Yes	Yes
Suitable for saltwater	No	No	No	No
Item no.	88710	88681	88692	88700

BLEND WITH VITAMINS, AQUATIC PIGMENTS AND SHRIMP TREATS

DYNAMIX Sticks Mix + Snack

- **Snack:** Including shrimp treats in every mixture
- **Fish target group:** Suitable for all ornamental fish, suitable for mixed ponds containing species with natural or red pigmentation
- **The food with pep:** Pepper has prebiotic properties, which improves a fish's ability to absorb vitamins
- **Intensity:** Aquatic pigments are used by fish for their own colour development

- **DYNAMIX effects no. 1–3:** see page 70



PRODUCT	DYNAMIX STICKS MIX + SNACK 4 L	DYNAMIX STICKS MIX + SNACK 8 L	DYNAMIX STICKS MIX + SNACK 20 L
Net weight	480 g	960 g	2400 g
Suitable for freshwater	Yes	Yes	Yes
Suitable for saltwater	No	No	No
Item no.	88684	88694	88702

DYNAMIX Super Mix

- **Fish target group:** For all ornamental fish and koi in mixed ponds
- **The food with pep:** Pepper has prebiotic properties, which improves a fish's ability to absorb vitamins
- **Intensity:** Aquatic pigments are used by fish for their own colour development
- **DYNAMIX effects no. 1–3:** see page 70



PRODUCT	DYNAMIX SUPER MIX 1 L	DYNAMIX SUPER MIX 4 L	DYNAMIX SUPER MIX 8 L	DYNAMIX SUPER MIX 20 L
Net weight	165 g	660 g	1320 g	3300 g
Suitable for freshwater	Yes	Yes	Yes	Yes
Suitable for saltwater	No	No	No	No
Item no.	88709	88687	88697	88705



PELLETS FOR GROWTH AND VIBRANT COLOURS IN SMALLER KOI MEASURING UP TO 20 CM

DYNAMIX Koi Pellets Small

- **Shape and colour:** Pellets with spirulina, soybean meal and red rice support the metabolism for uniform growth and intensive colour development
 - **Fish target group:** For smaller koi in the pond with a body length up to 20 cm
 - **Intensity:** Aquatic pigments are used by fish for their own colour development
- **DYNAMIX effects no. 1–3:** see page 70



PRODUCT	DYNAMIX KOI PELLETS SMALL 1 L	DYNAMIX KOI PELLETS SMALL 4 L	DYNAMIX KOI PELLETS SMALL 8 L	DYNAMIX KOI PELLETS SMALL 20 L
Net weight	350 g	1400 g	2800 g	7000 g
Suitable for freshwater	Yes	Yes	Yes	Yes
Suitable for saltwater	No	No	No	No
Item no.	88706	88685	88695	88703

PELLETS FOR GROWTH AND VIBRANT COLOURS IN LARGER KOI MEASURING 20 CM AND ABOVE

DYNAMIX Koi Pellets Large

- **Shape and colour:** Pellets with spirulina, soybean meal and red rice support the metabolism for uniform growth and intensive colour development
 - **Fish target group:** For larger koi in the pond with a body length of 20 cm and over
 - **Intensity:** Aquatic pigments are used by fish for their own colour development
- **DYNAMIX effects no. 1–3:** see page 70



PRODUCT	DYNAMIX KOI PELLETS LARGE 4 L	DYNAMIX KOI PELLETS LARGE 8 L	DYNAMIX KOI PELLETS LARGE 20 L
Net weight	1400 g	2800 g	7000 g
Suitable for freshwater	Yes	Yes	Yes
Suitable for saltwater	No	No	No
Item no.	88686	88696	88704

Care products and fish medicine





Further information
is available at:
[www.oase.com/en/
pond-treatments-
fishmedicine](http://www.oase.com/en/pond-treatments-fishmedicine)

78 AquaActiv care products

78 TYPICAL POND PROBLEMS – OUR SOLUTIONS

79 STARTER CULTURES

80 IMPROVE WATER QUALITY

81 WATER PURIFIER – PROBLEM SOLVER

81 DECHLORINATOR

82 BIND NUTRIENTS

82 PHOSLESS FLOW – FILTER CARTRIDGES

83 COMBAT/PREVENT ALGAE

84 CLEANING AND MAINTENANCE

85 POND CARE WITH AQUAACTIV

86 AquaActiv fish medicine

86 FISH MEDICINE

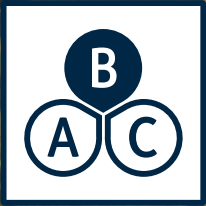

A-B-C-D CONCEPT

Typical pond problems – our solutions

Pond water quality is key for plants and pond inhabitants. The OASE pond care concept consists of **three stages** plus disinfection and cleaning for ornamental fountains, large ponds and swimming ponds without living organisms.



A: Improve water quality

Natural preparation and enrichment of pond water



B: Bind nutrients

Nutrient binding without biocides

If A and B are not sufficient, then follow with C.



C: Combat algae

OASE algaecides against excessive and therefore harmful algae growth



D: Cleaning and maintenance

Effective for water features without living organisms

FOR USE IN FILTERS AND PONDS

Starter cultures

They provide the crucial kick-start in the filter and pond, which is vital for the biological balance of the water.

The OASE test sets always give you a clear overview of your water quality. This allows you to detect problems early on and take countermeasures before fish or plants are damaged.

OASE TEST SET

QuickSticks 6in1

WATER ANALYSIS

- Six-in-one:** Quick and easy analysis of the six most important water parameters
- Good price/performance:** Enough to test 50 water samples, i.e. 300 parameters
- Works fast:** Only takes one minute

Item no. **50570**







BioKick

STARTER CULTURES FOR USE IN FILTERS AND PONDS

- Starting aid:** Awakens the pond biology in the filter during spring
- Performance booster:** Immediately active microorganisms for best filter performance

Ponds up to max.	(m ³) 5.00	(m ³) 10.00	(m ³) 100.00
Item no. (GB Version)	Not available in GB	75834	-
Item no.	51277	50295	50939



BioKick Fresh

STARTER CULTURES FOR USE IN FILTERS AND PONDS

- Starting aid:** Activates the pond biology in the filter in spring or upon restarting the pond
- Billions strong:** Contains more than 50 billion microorganisms* (*at the time of filling)
- Performance booster:** Optimum pond filter performance reached within just 1–2 weeks

Ponds up to max.	(m ³) 10.00
Item no. (GB Version)	75837
Item no.	50562



BioKick Premium

HIGHLY CONCENTRATED STARTER CULTURES FOR USE IN FILTERS AND PONDS

- Thorough cleaning:** Highly concentrated filter bacteria for filter systems handling heavily contaminated water
- Billions strong:** Contains more than 50 billion microorganisms (at the time of filling)
- Performance booster:** Optimum pond filter performance reached within just a few days

Ponds up to max.	(m ³) 40.00
Item no. (GB Version)	75840
Item no.	51280

PRODUCT	BIOKICK	BIOKICK FRESH	BIOKICK PREMIUM
Number of bacteria (at the time of filling)	1 x 10 ⁷ /ml	1 x 10 ⁹ /ml	5 x 10 ¹⁰ /ml
Ideal for	natural ponds	Fish ponds with moderate fish stocks	Koi ponds
Filter performance within	a few weeks	1–2 weeks	a few days

OPTIMALLY SUPPORT POND BIOLOGY – WITH A TWO-PHASE EFFECT

A: Improve water quality



Safe use

For fish stocks, the DuoBoost balls can be put into a practical net.



Rapid development of the filter biology

To support the pond biology, the DuoBoost balls can be inserted directly into the filter.



Basis for clear water

By supporting pond biology and improving water values, the basis for a healthy water is created.



78110: Ø 5 cm



78111/78112: Ø 2 cm

DuoBoost

EFFECTIVE WATER PURIFIER

- **Basis for clear water:** Positively influences pond biology
- **Straightforward:** Place the gel and ball directly in the filter or pond; if the pond contains fish, place the balls in the enclosed net
- **For all pond types:** Important trace elements and minerals for all types of pond
- **Two-phase effect:** Use in two phases: 1. A gel made of highly active enzyme and bacterial fluid to break down organic pollutants, ammonium and nitrites, and to activate the filter biology. 2. Soluble balls with a diameter of 2 cm or 5 cm. These balls releases important trace elements, cosubstrates, minerals and valuable additives into the pond.

	Ø 5 cm	Ø 2 cm	
Ponds up to max.	(m ³) 20.00	(m ³) 30.00	(m ³) 90.00
Item no.	78110	78111	78112

INFO

DuoBoost has been specially developed to support pond biology. It consists of two complementary phases of action:

The **first phase of action** is a **gel** that is placed straight in the pond or the filter chamber. This gel is a highly active fluid containing enzymes and bacteria that removes organic dirt, ammonium and nitrite. The filter bacteria are activated at the same time.

The **second phase of action** is a **ball** measuring 2 cm or 5 cm in diameter that dissolves over time, releasing important trace elements, cosubstrates, minerals and valuable additives that are otherwise difficult to put into an artificial pond.

The **treatment** with DuoBoost can be repeated several times a year if required. Both phases lay the foundations for achieving clear, healthy water and exceptional pond biology. However, if the water is green, you should use a UVC clarifier to remove the algae causing the problem.

BASIS FOR STABILISING WATER

Water treatment



OptiPond

STABILISES THE MOST IMPORTANT WATER VALUES

- **Purifier:** Treats soft well water and rainwater to ensure that it is suitable for the application
- **Supplement:** Adds essential minerals and macro elements
- **Instant aid:** Helps to resolve acute problems caused by excessive levels of ammonia, nitrite or heavy metal in the pond

Ponds up to max.	(m ³) 5.00	(m ³) 50.00
Item no. (GB Version)	75823	-
Item no.	50557	50558



Safe&Care

WATER TREATMENT WITH MUCOSA PROTECTION

- **Purifier:** Treats filling water so that it is suitable for fish and biotopes
- **Eliminator:** Quickly and reliably binds heavy metals and removes chlorine
- **Fish friendly:** Protects mucous membranes from becoming irritated and strengthens the gills
- **No stress:** Reduces the stress levels of fish using vitamin complexes

Ponds up to max.	(m ³) 10.00
Item no. (GB Version)	70449
Item no.	50563



BioKick Care

BIOLOGICAL POND CARE

- **Activator:** Revitalises the pond water by introducing particularly important bacterial strains
- **Clarifier:** Creates sustainably healthy, very clear pond water, ensuring visibility right into the depths
- **Colour booster:** These natural minerals enhance the colouring of your fish
- **Probiotic:** Valuable probiotics boost the immune system and enhance the well-being of your fish

Ponds up to max.	(m ³) 5.00	(m ³) 50.00
Item no. (GB Version)	Not available in GB	
Item no.	51283	51288



PROBLEM SOLVER:

SediFree

EFFECTIVE AGAINST POND MUD

- Contains high-performance bacteria to degrade organic sludge deposits
- Accelerates sludge removal effectively – using 2-component technology with active oxygen granulate
- Works naturally
- Prevents both of the following in a targeted way: Sludge formation and prolonged turbidity

Ponds up to max.	(m ³) 5.00	(m ³) 100.00
Item no. (GB Version)	75820	-
Item no.	50560	50561



OxyPlus

INCREASES THE OXYGEN CONTENT

- Prevents the formation of dangerous gases
- With controlled sustained release
- Rapid remedy in case of oxygen deficiency, e.g. in the case of algae outbreaks or nitrite poisoning
- Supports biological self-cleaning. Removes brown water discolourations

Ponds up to max.	(m ³) 10.00
Item no. (GB Version)	75828
Item no.	50559

INFO

Dechlorinator reliably detoxifies chlorine-contaminated tap water. Ideal for filling ponds and aquariums.



Item no.: 48790



B: Bind nutrients



PondLith

PROTECTION AGAINST ALGAE OUTBREAKS

- **High purity:** Finest natural zeolite, in the grain size 5–10 mm. In a practical filter media bag
- **High performance:** Particularly powerful filter material for the removal of nitrogen compounds
- **For emergencies:** Quick aid in case of ammonium excess
- **Let's get started:** Ideal support of your filter during the run-in phase
- **Starved out:** Leaves algae without important food sources

Ponds up to max. (m³) 2.50
Item no. (GB Version) Not available in GB
Item no. 54049



PhosLess Direct

ALGAE PROTECTION BY BINDING NUTRIENTS

- **Live physics:** Physically removes the phosphate that algae feeds on
- **Easy on the nose:** Effectively binds to hydrogen sulphide before unpleasant odours can occur
- **For emergencies:** Rapid aid for elevated phosphate levels

Ponds up to max. (m³) 10.00 (m³) 100.00
Item no. (GB Version) 75817 -
Item no. 51284 51287



AquaHumin

NATURAL NUTRIENT REMOVAL

- **Humin substances:** Special peat for the garden pond
- **Useful:** Delivered in a practical mesh bag
- **Sunglasses effect:** Physical algae prevention

Ponds up to max. (m³) 10.00
Item no. (GB Version) Not available in GB
Item no. 53759



PhosLess

BIOLOGICAL PROTECTION

- **Eliminator:** Quickly and reliably binds chlorine and heavy metals such as copper, lead and zinc
- **Reliable supply:** Also available in a useful refill pack
- **Duo-Tec:** Particularly effective thanks to the two-component technology in the exchange system
- **Permanent solution:** Effectively removes phosphate for the long-term
- **Live physics:** Physically removes the phosphate that algae feeds on

Ponds up to max. (m³) 40.00 (m³) 40.00
Item no. (GB Version) 75828
Item no. 36981 57477

Phosphate binding in perfection with PhosLess Flow 3000 cartridges



PhosLess Flow 3000

REMOVAL OF PHOSPHATES

- Ideal start for phosphate levels > 0.2 mg/l
- Binding capacity: 90 g PO₄³⁻
- Prepares the pond for use of the PhosLess PowerFlow

Item no. (GB Version) -
Item no. 48792

PhosLess Power Flow 3000

HIGHLY REACTIVE ABSORBER

- Significantly reduces the phosphate content below the minimum algae requirement
- Recommended for sustainable use from values < 0.2 mg/l
- Binding capacity: up to 150 g PO₄³⁻
- For swimming ponds up to 75 m³ usually sufficient for one swimming season

Item no. (GB Version) -
Item no. 48791

Secure Flow 3000

PRE-FILTER FOR PHOSLESS FLOW

- With easy-to-rinse glass beads
- Required if pre-filtered water is not available

Item no. (GB Version) -
Item no. 48793

CREATES CLEAR POND WATER



C: Combat algae



PondClear*

CREATES CRYSTAL-CLEAR WATER

- Makes cloudy ponds clear again
- Reliably combats even the finest, unfilterable impurities
- Helps you safely remove phosphates

Ponds up to max.	(m ³) 10.00	(m ³) 100.00
Item no. (GB Version)	70453	-
Item no.	50552	50555



ALGo Universal*

EFFECTIVE ALGAE CONTROL

- Powerful aid for combating the most common types of algae, such as thread algae, slime algae and brown algae
- Effectively slows down algal metabolism
- Significantly reduces the formation of new algae

Ponds up to max.	(m ³) 10.00	(m ³) 100.00
Item no. (GB Version)	70450	-
Item no.	50542	50545



ALGo Direct*

RAPIDLY EFFECTIVE AGAINST THREAD ALGAE

- Works through direct contact
- Ideal for treating localised infestations, e.g. in watercourses
- Includes: a KH rapid test for safe application
- Also suitable for use in swimming ponds

Ponds up to max.	(m ³) 10.00	(m ³) 100.00
Item no. (GB Version)	70451	-
Item no.	50546	50549



ALGo Greenaway*

FOR CRYSTAL-CLEAR POND WATER

- Sustainably eliminates floating algae – the cause of green water
- The ideal alternative for preventing green and blue algae growth
- Extremely simple to use. Officially certified and approved biocidal product

Ponds up to max.	(m ³) 10.00
Item no. (GB Version)	70452
Item no.	40235

COMMON ALGAE SPECIES IN GARDEN PONDS



Thread algae

Recommendation: **ALGo Universal*** and **ALGo Direct***



Floating algae

Recommendation: **PondClear*** and **ALGo Greenaway***



Red algae

Recommendation: **ALGo Universal***

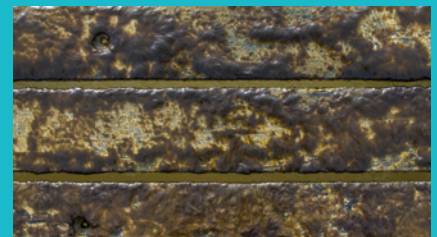

Diatoms

Recommendation: **ALGo Universal*** and **ALGo Direct***



Blue algae

Recommendation: **ALGo Greenaway*** and **ALGo Direct*** + comprehensive pond hygiene

RECOMMENDATION

Many AquaActiv products are also available in attractively priced large containers.

*Use biocidal products carefully. Always read the label and product information before use.



D: Cleaning and maintenance



ALGo Fountain*

ALGAE PROTECTION FOR WATER FEATURES

- **Hassle-free:** Thanks to long-lasting effects
- **Indoors and outdoors:** Keeps ornamental fountains and other decorative water features sparkling fresh and clear
- **Instant aid:** Urgent assistance against algae, odours and slippery surfaces
- **Stops limescale:** Prevents limescale buildup

Ponds up to max.	(m ³) 0.20	(m ³) 10.00
Item no. (GB Version)	75803	-
Item no.	51278	40234

OxyPool*

CHLORINE-FREE POND PROTECTION

- **Cleaner:** Reliably eradicates algae, bacteria and fungi without the use of chlorine
- **Versatile:** Suitable for animal-free water bodies, e.g. pools, water features, fountains or ponds
- **Germ-free:** With disinfecting properties

Ponds up to max.	(m ³) 100.00
Item no. (GB Version)	Not available in GB
Item no.	88252

PumpClean

CLEAN POND TECHNOLOGY WITH EASE

- **Effective:** Cleans pond technology, such as pumps, sieves, quartz glass etc.
- **Works!** Reliably removes limescale and other deposits
- **Concentrated:** Makes a total of 10 l of cleaning solution
- **Long life:** Significantly prolongs the service life of your pond pump

Item no. (GB Version)	75806
Item no.	40242



THE RIGHT PRODUCT FOR EVERY SEASON

Pond care with AquaActiv



Spring

PURIFY WATER, ACTIVATE POND BIOLOGY AND BIND NUTRIENTS AT THE START OF THE SEASON

- **OptiPond** standard care for optimal water conditions
- **BioKick** filter starter gets the filter biology going
- **PondoLith Zeolite** reduces ammonium or nitrite during the startup phase
- **QuickSticks** and **water analysis set** monitor the water values
- **PhosLess** reduces phosphates and helps prevent thread algae
- **SediFree** reduces deposits on the bottom – ideally combined with the PondoVac
- **Fish medicine** provides a remedy for diseases affecting the fish stock



Summer

SUMMERTIME IS ALGAE TIME

- Effectively combat algae in three stages with the **AquaActiv A-B-C anti-algae programme**
- Take care of algae growth with **AquaHumin**
- **OptiPond** balances the minerals and thus prevents dangerous pH fluctuations
- **Safe&Care** prepares tap water to make it suitable for the pond
- **OxyPlus** fights oxygen deficiency due to algae bloom during warm temperatures



Autumn

LARGE-SCALE CLEANING BEFORE THE WINTER

- Use the **PondoVac** to remove dead plant residues, detritus and sludge
- **SediFree** helps with sludge degradation
- **BioKick Care** optimises the water values
- **OptiPond** prevents pH fluctuations

Winter

REST TIME FOR THE POND AND ITS INHABITANTS

- **PumpClean** cleans and maintains the pond technology
- **PhosLess** filter cartridges prevent thread algae forming in the new season
- **QuickSticks** and the **water analysis set** control the water values, especially when the fish are fed through the winter



*Use biocidal products carefully. Always read the label and product information before use.

AquaActiv fish medicine



Universal**

AGAINST THE MOST COMMON POND FISH DISEASES

Area of application

- Unclear diagnosis
- Mixed infections
- For preventing diseases
- Bacterial infection
- Single-cell parasites (protozoa)
- Fungal diseases

Symptoms

- Whitish yellow, slimy coverings
- Coverings that resemble cotton wool
- Ulcers, wounds, inflammations
- Flicking
- Loss of skin & scales
- Blood spots

Ponds up to max.	(m ³) 10.00	(m ³) 100.00
Item no. (GB Version)	Not available in GB	
Item no.	50564	50297

1 AntiParasit**

AGAINST SINGLE-CELLED PARASITES

Area of application

- Single-cell parasites (protozoa) such as skin parasites (Costia, Trichodina, Chilodonella), spot disease (Ichthyophthirius)
- Velvet disease (Oodinium)
- Cryptobia
- Bacterial diseases that accompany these parasites

Symptoms

- White-grey to dark, velvet-like coverings
- White spots
- Projecting gills
- Increased respiratory activity
- Scraping against objects
- Clamped fins
- Apathy and weight loss

Ponds up to max.	(m ³) 10.00	(m ³) 100.00
Item no. (GB Version)	Not available in GB	
Item no.	50565	50928

2 AntiPilz**

AGAINST FUNGAL INFECTIONS

Area of application

- Fungal diseases (Dermocystidium)
- Mould (Saprolegnia)
- Bacterial diseases that accompany these parasites
- Note: Fungal infections are common on injured skin areas

Symptoms

- Cotton wool-like coverings on gills, bodies and fins
- Whitish brownish covering on wounds

Ponds up to max.	(m ³) 10.00	(m ³) 100.00
Item no. (GB Version)	Not available in GB	
Item no.	50566	50929



Pharmaceutical operator/
manufacturer:

**Aquarium
Münster**

Fish like us





1 Parasite infestation



2 Fungal infection



4 Fish lice infestation



1 Parasite infestation

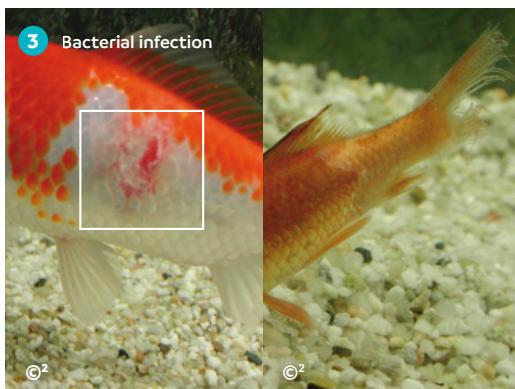

3 Bacterial infection



4 Anchor worms



The illustrations are subject to the copyright of:
©1 Dr Achim Bretzinger; ©2 Dr Gerald Bassleer

3 AntiBacteria**

FIGHTS INTERNAL AND EXTERNAL BACTERIAL INFECTIONS

Area of application

Internal and external bacterial infections such as

- Ascites (Aeromonas, Pseudomonas)
- Mouth rot (Columnaris)
- Fin rot (myxobacteria)
- Hole in the head disease (Aeromonas, Pseudomonas)
- Streptococcus
- Inflamed injuries

Symptoms

- Loss of skin & scales
- Swelling, redness
- Broken skin, open wounds, ulcers
- Fin rot, raised scales
- Slowed/accelerated movements
- Flicking, cramps
- General darkening
- Protruding bellies

Ponds up to max. (m³) 10.00 (m³) 100.00

Item no. (GB Version) Not available in GB

Item no. 50568 50931

4 AntiArgulus**

ACTIVE SUBSTANCE: DIFLUBENZURON AGAINST FISH LICE

Area of application

- Fish lice (Argulus)
- Anchor worms (Lernaea)
- Gill cancer (Ergasilus)

Symptoms

- Fish lice, anchor worm, fish leech (visible with the naked eye)
- Heavy scraping against objects
- Lethargy and emaciation

Ponds up to max. (m³) 10.00 (m³) 100.00

Item no. (GB Version) Not available in GB

Item no. 50567 50936

TIP

OUR RECOMMENDATION FOR SEVERE CASES

Dr Achim Bretzinger, 89415 Lauingen, Germany
Dr Sandra Lechleiter, 75305 Neuenbürg, Germany

Over-the-counter medicines in accordance with Section 60 of the German Drug Act (AMG)
* GMP quality standards (Good Manufacturing Practice – guarantees constant physical, chemical and microbiological inspections, from receipt of raw materials to manufacturing of the product)
** The products Universal, AntiParasit, AntiPilz, AntiBakterien and AntiArgulus are over-the-counter medications in accordance with Section 60 of the German Drug Act (AMG).

Smart garden control systems & lighting





Further information
is available at:
[www.oase.com/en/
garden-control-
systems/lighting](http://www.oase.com/en/garden-control-systems/lighting)

90 Guide

- 90 LIGHTING CONCEPT
- 92 OASE CONTROL
- 94 LUNAQUA CONNECT

102 LED spotlights

- 102 LUNAQUA TERRA LED
- 102 LUNALED
- 103 LUNAQUA POWER LED
- 103 PROFILUX GARDEN LED RGB
- 104 LUNAQUA CLASSIC LED
- 104 LUNAQUA 3 LED
- 106 LUNAQUA POWER LED XL

107 Garden control systems

- 107 GARDEN CONTROLLER CLOUD
- 108 INSCENIO FM-MASTER CLOUD
- 109 INSCENIO

Tips for optimal showcasing of your garden



To design the lighting in your own garden, proper planning is essential. OASE offers garden owners a variety of ways to add a special charm to the greenery with cleverly placed lighting effects. Benefits of the OASE lighting range: The installation is simple, making the effect even more stunning. We are happy to help you decide which spotlight from the OASE LunAqua series is the right one to perfectly stage your garden. For this reason, we have pictured all the models in

one photo series. What makes these pictures special: So you can assess the light effect of the different spotlights, each of them is shown in an identical perspective – with a distance of 70 cm from the wall. Compare, select and create a magical, glowing oasis of tranquillity in your pond.

TIP

POWER SOURCES

Sufficient power sources throughout the appropriate parts of your garden facilitate the light installation. The remote-controlled FM masters (page 100) are a particularly practical solution. They allow the lighting to be conveniently controlled from the comfort of your terrace. The revolutionary Garden Controller Cloud even allows convenient app control from your smartphone or tablet.

Test it out!



LunAqua Power LED W
WARM WHITE



LunAqua Power LED XL
WARM WHITE

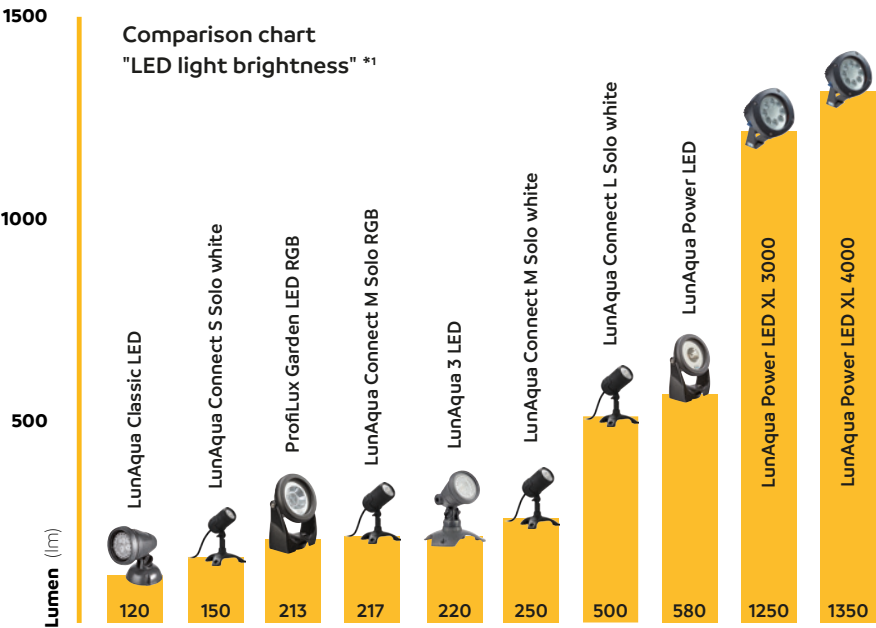

EXTRAS

WATTS DO NOT EQUAL OUTPUT

Most people's image of luminosity stems from a classic 25 W incandescent lamp. The economical LED lamps lack this relationship between power consumption and brightness. To compare the brightness of different lamps, the luminous flux (given in "lumens") is therefore what counts. To give an example: at 580 lumens, the luminosity of our LunAqua Power LED lamp is approximately equivalent to a 50 watt incandescent lamp. It only requires only 5.8 W for this luminosity. See the comparison diagram on the left for additional lamps.

*1 Further information on the energy efficiency class on page 128.

SWITCH ON AND THEN SIT BACK AND RELAX –
WHEREVER YOU ARE.

OASE Control



On holiday or on the go, on the sofa or on a sun lounger: Control and monitor your garden technology and entire pond system, from filters to lighting, conveniently from your smartphone with the smart OASE Control system. Get push notifications about the status of your devices any time, anywhere, so you can respond when you need to. Experience a whole new dimension of convenience and relaxation.

Be it pump delivery, filter flushing or fountain height – all the functionalities of compatible pond devices can be easily controlled from your smartphone. You can also use the cloud version of the system as needed to check important parameters, such as the water temperature, and view interesting analyses of filter functions.

A fast response – anytime, anywhere: the InScenio FM-Master or Garden Controller is easy to connect to your home network. The additional benefit of the cloud variant is the ability to monitor from anywhere. Even when at work, travelling for business or on holiday with the family, garden and pond owners are notified immediately via email and push notification in the event of malfunctions and discrepancies. This gives you the opportunity to respond appropriately at any time. Peace of mind – wherever you may be.

Download the free OASE Control app now.



DOWNLOAD THE APP NOW

App Store



DOWNLOAD THE APP NOW

Google Play



Smart home – smart relaxing

Use our know-how as the basis
for your ideas and success.



For more information including the terms
of use, please visit:
www.oase.com/en/oase-control

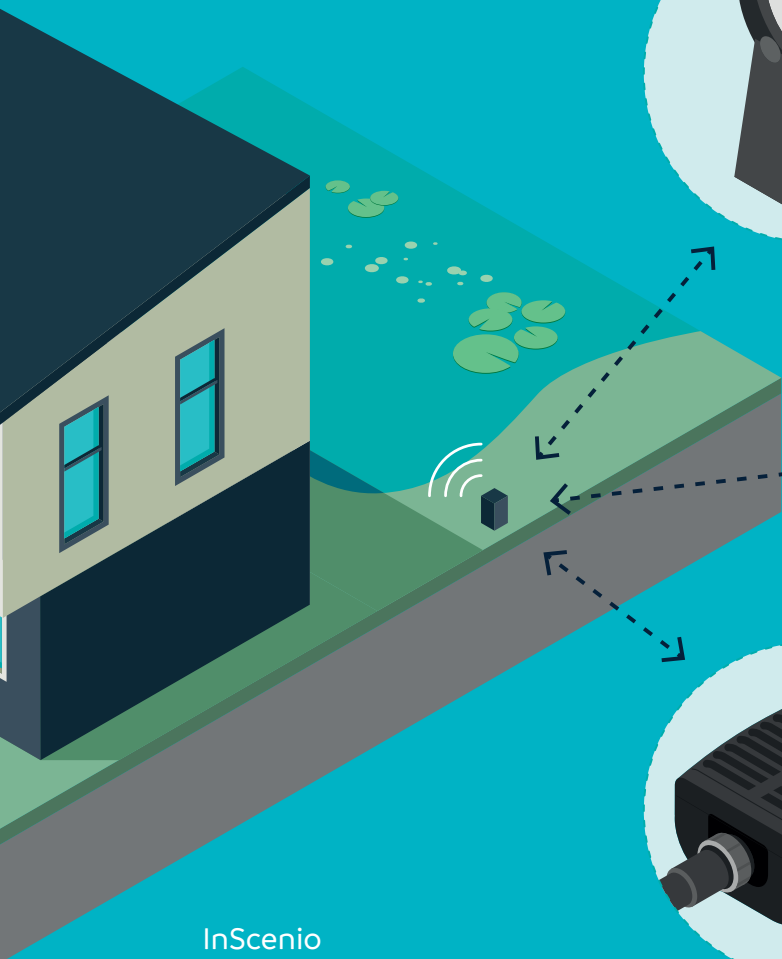

ProfiLux Garden LED
(> See page 103)

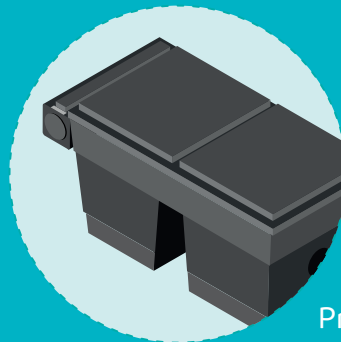

ProfiClear Premium
(> See page 43)



AquaMax Eco Premium
(> See page 26)

AquaMax Eco Expert
(> See page 28)

AquaMax Eco Titanium
(> See page 29)

InScenio
FM-Master/Garden
Controller
(> from page 108)

LunAqua Connect: The system explained

The universal lighting system for gardens and ponds – flexible use for illumination of ponds, water features, flower beds, hedges and buildings.



Modular system

The LunAqua Connect system is a modular concept that can be expanded at any time. It can be started either with one of three sets or with individual components – depending on your application and requirements. Extension cables, outlet cables and three-way distributors can be used to provide light precisely where you need it in your garden and pond. Furthermore, the LunAqua Connect controller can be retrofitted later to enable smart control.



RGB light, white light or both!

The RGB and white lights feature IP68 degree of protection and are therefore suitable for permanent use under and above water. In addition, they can be easily controlled via the OASE Switch controller and OASE Switch app on your smartphone or tablet. Each controller has two outputs for white lights and one output for RGB lights.



Smart control system

White spotlights can be operated either via the power supply or via the OASE Switch controller and app (controller is required for RGB lights). This control system enables you to dim white lights, select the colours of RGB lights and set the timer for both light types.



Connections for white and RGB

The plugin connection technology with IP67 degree of protection allows temporary submersion (e.g. due to rainfall) in puddles and burying in flower beds, for example.

LunAqua Connect – step by step

Step-by-step guide to choosing the right lighting system for your garden and pond

1. Lights

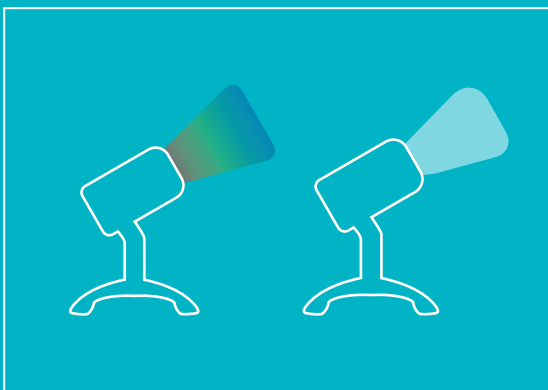

Use the application overview to select suitable spotlights. (See page 96/97).

2. Optional control system

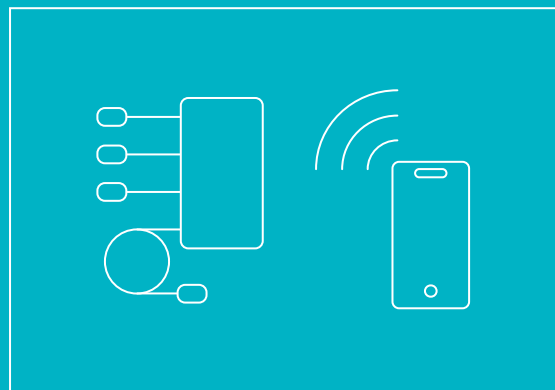

Add the OASE Switch controller as desired. (Required for RGB)

3. 36 W power supply

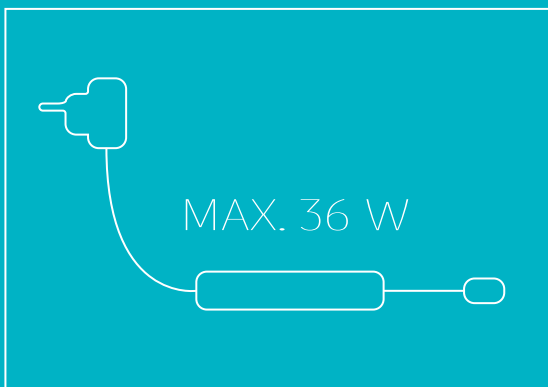

Add a power supply (total power consumption of all connected lights must not exceed 36 W)

4. Accessories (optional)

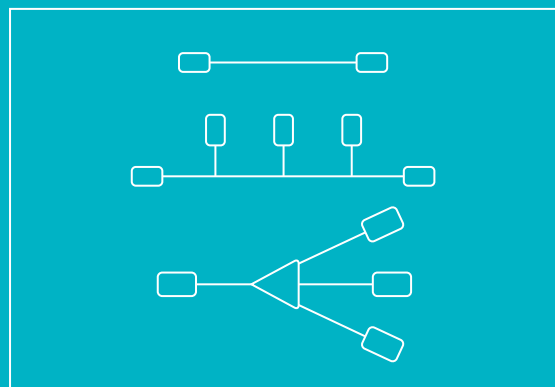

Choose accessories from 5 m and 10 m extension cables with four outlets and three-way distributors (available for both white and RGB)

Application areas

The LunAqua Connect system offers the right light for every garden application – whether under or above water.



Tip: Tall objects are best illuminated from the bottom upwards. Depending on the desired effect, it is worth experimenting to find the ideal distance between the light and the object and, if necessary, positioning the light slightly further away.

Bushes

Application	Small bushes up to 0.5 m high
Ideal light	LunAqua Connect S
Application	Large bushes up to 1 m high
Ideal light	LunAqua Connect M

Trees

Application	Small tree up to 2 m high
Ideal light	LunAqua Connect M (at least two lights)
Application	Medium tree up to 5 m high
Ideal light	LunAqua Connect L (at least two lights)

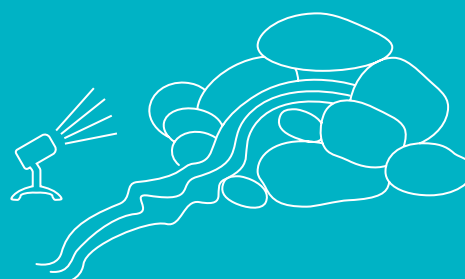
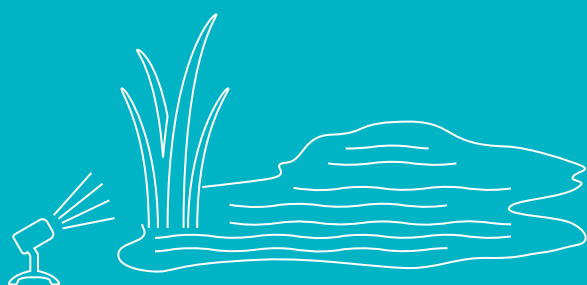

Ponds and water features

Application	Shallow and deep ponds and water features
Ideal light	LunAqua Connect S, LunAqua Connect M

Watercourses

Application	Watercourses, spring stones or waterfalls
Ideal light	LunAqua Connect S, LunAqua Connect M

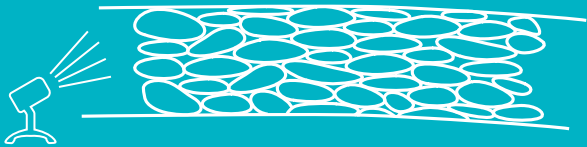

Path lighting

Application	Edge lighting on paths to prevent tripping
Ideal light	LunAqua Connect S

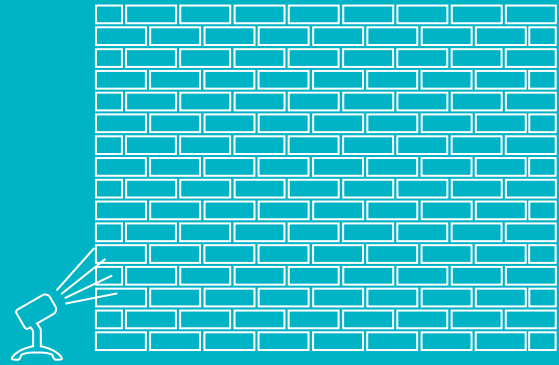

Buildings and summer houses

Application	Illumination of walls up to approx. 1.50 m high
Ideal light	LunAqua Connect M
Application	Illumination of walls up to approx. 3 m high
Ideal light	LunAqua Connect L



Garden decoration

Application	Sculptures, ornaments, architectural objects up to 0.5 m high
Ideal light	LunAqua Connect S
Application	Up to 2 m high
Ideal light	LunAqua Connect M

Examples of combinations

The LunAqua Connect system adapts flexibly to your garden: Thanks to the extensive accessory range of cables and distributors, the system can be expanded at any time – whether it is controlled via the OASE Switch controller and app or not.

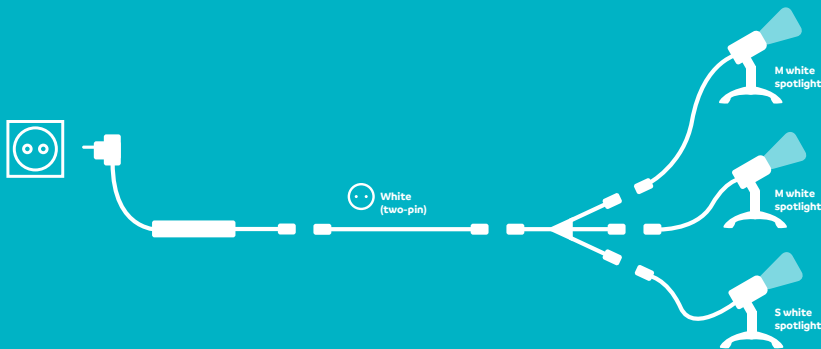

Example 1: White spotlights without control system

- 1x LunAqua Connect S spotlight (power consumption 2.5 W)
- 2x LunAqua Connect M spotlight (power consumption 2x 4 W)
- 1x LunAqua Connect three-way distributor
- 1x LunAqua Connect White 5 m extension cable
- 1x LunAqua Connect 36 W power supply

Total power consumption of spotlights:
 $2.5\text{ W} + 4\text{ W} + 4\text{ W} = 10.5\text{ W} < 36\text{ W}$ ✓

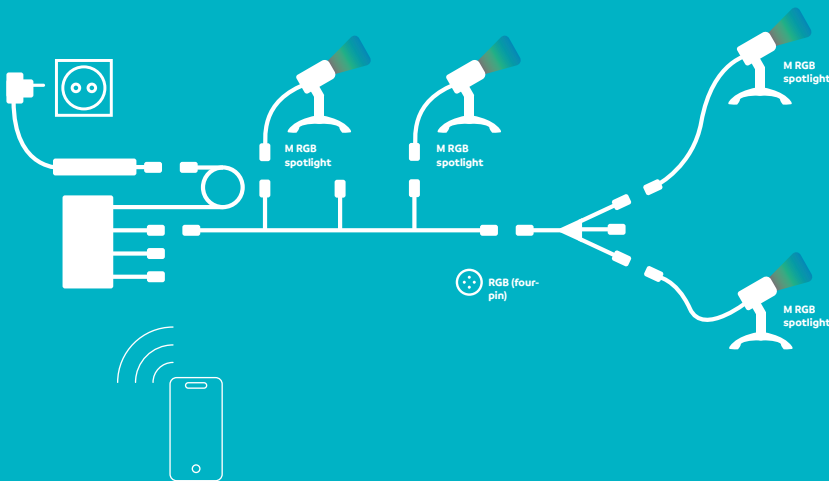

Example 2: RGB spotlights (control system required)

- 4x LunAqua Connect M RGB spotlight (power consumption 4x 7.5 W)
- 1x LunAqua Connect three-way distributor
- 1x LunAqua Connect RGB 10 m outlet cable
- 1x LunAqua Connect OASE Switch controller
- 1x LunAqua Connect 36 W power supply

Total power consumption of spotlights:
 $7.5\text{ W} + 7.5\text{ W} + 7.5\text{ W} + 7.5\text{ W} = 30\text{ W} < 36\text{ W}$ ✓

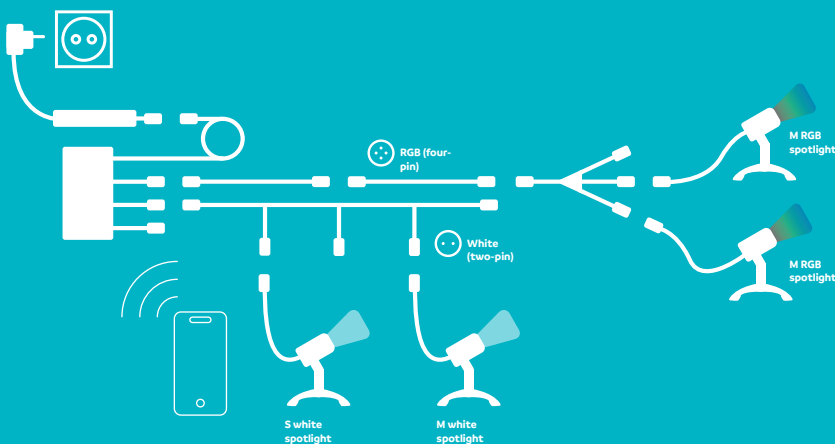

Example 3: White and RGB spotlights in one system (control system required)

- 2x LunAqua Connect M RGB spotlight (power consumption 2x 7.5 W)
- 1x LunAqua Connect S white spotlight (power consumption 2.5 W)
- 1x LunAqua Connect M white spotlight (power consumption 4 W)
- 1x LunAqua Connect RGB three-way distributor
- 2x RGB 5 m extension cable
- 1x white 10 m outlet cable
- 1x LunAqua Connect OASE Switch controller
- 1x LunAqua Connect 36 W power supply

Total power consumption of spotlights:
 $7.5\text{ W} + 7.5\text{ W} + 4\text{ W} + 2.5\text{ W} = 21.5\text{ W} < 36\text{ W}$ ✓

Example of use

Use of the system for gardens and ponds



HOW MANY LIGHTS PER SYSTEM?

The number of lights connected to the 36 W power supply must not exceed a total power consumption of 36 W. If the power consumption of 36 W is exceeded, an additional power supply and, if necessary, an additional controller are required to install a second system.

SMART CONTROL

The LunAqua Connect controller can be used to control both white and RGB spotlights from your smartphone or tablet using the OASE Switch app – at a distance of up to 40 m from the controller.

ONE CABLE FITS ALL

The 10 m outlet cable with four outlets enables lights to be easily positioned along flower beds, hedges or paths.

DIRECT CONNECTION TO A SOCKET

For white spotlights, it is not necessary to use the LunAqua Connect controller – the lights can also be operated via the power supply and corresponding two-pin extension cables and distributors. However, the controller can be retrofitted at any time to use the timer or to dim the spotlights via the OASE Switch app.

EXTENSION

Every cable from the controller or power supply can be extended as desired (up to 100 m per cable), enabling them to reach even the furthest corners of your garden.

IP67* CONNECTION TECHNOLOGY

The robust plugin connections mean that the cables and connectors can easily withstand rain showers and puddles and can also be buried.

IP68 SPOTLIGHTS

The LunAqua Connect spotlights are all suitable for permanent operation under water – no matter whether in a pond, in shallow water or for illuminating water features.

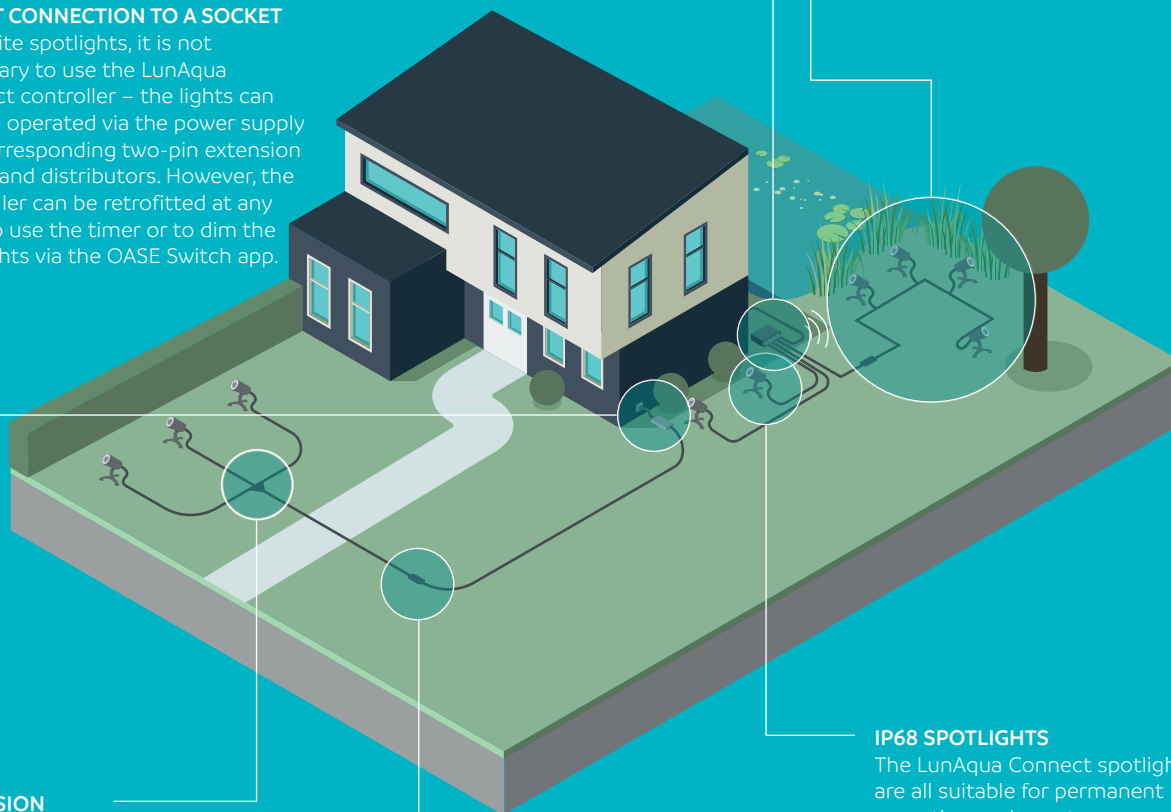

*IP67 is suitable for temporary submersion under water.

Available from the second quarter of 2024



LunAqua Connect Starter Set

controllable



- **Everything included:** Complete set of 1x M white spotlight and 1x M RGB spotlight, one OASE Switch controller and one 36 W power supply
- **Excellent light quality:** A high colour rendering index (CRI) of over 90 ensures natural, intense lighting with rich colours
- **Smart:** Easy control of dimming, colour selection and timer via the OASE Switch controller and app for smartphone or tablet*³
- **RGB, white or both:** RGB and white lights can be controlled in one system via the OASE Switch controller and app and can be expanded at any time (two white cables and one RGB cable per controller)

PRODUCT	LUNAQUA STARTER SET CONTROLLABLE
Dimensions (Ø x H)	61 x 98 mm
Rated voltage (primary, secondary)	230 V AC/24 V DC
Lamp power consumption	M spotlight 4 W, M RGB spotlight 7.5 W
Energy efficiency class of lamp ^{†1}	G
Guarantee (+ request guarantee) ^{†2, †3†1}	2 + 1 years
Luminous flux	250 lm/217 lm
Item no. (GB Version)	-
Item no.	74350

*³ System requirements: iOS 12.5 (Apple) or Android version 7.0 or later is required to run the app on mobile devices.

LunAqua Connect accessories

Available from the second quarter of 2024



PRODUCT	LUNAQUA CONNECT CONTROLLER OASE SWITCH	LUNAQUA CONNECT 36 W POWER SUPPLY	LUNAQUA CONNECT WHITE 5 M EXTENSION CABLE	LUNAQUA CONNECT RGB 5 M EXTENSION CABLE	LUNAQUA CONNECT WHITE 10 M OUTLET CABLE	LUNAQUA CONNECT RGB 10 M OUTLET CABLE	LUNAQUA CONNECT WHITE THREE-WAY DISTRIBUTOR	LUNAQUA CONNECT RGB THREE-WAY DISTRIBUTOR
Power cable length	0.1 m		5.00 m		10.00 m		0.1 m	-
Cable cross-section	1 mm ² (white), 0.75 mm ² (RGB),		2 x 1 mm ²	4 x 0.75 mm ²	2 x 1 mm ²	4 x 0.75 mm ²	2 x 1 mm ²	4 x 0.75 mm ²
Material	-		H05RNF				Plastic	
Rated voltage	230 V AC/24 V DC							
Protection class	(Controller) IP44, (plugin connection) IP67, (power supply) IP67		IP67 ^{†2}					
Net weight	0.9 kg	0.20 kg	0.383 kg	0.474 kg	0.832 kg	1.115 kg	0.088 kg	0.047 kg
Warranty ^{†1} Page 131	2 + 1		2 + 1					
Item no. (GB Version)	-	-	-	-	-	-	-	-
Item no.	87032	90467	87037	74351	87511	74356	87039	87038

^{†1} Further information on the energy efficiency class on page 128.
^{†2} Suitable for temporary submersion, e.g. due to rainfall, in puddles or for burying

LUNAQUA CONNECT – THE FLEXIBLE MODULAR SYSTEM FOR GARDENS AND PONDS

LunAqua Connect Solo RGB

- **Flexible use:** RGB light for operation under and above water with 3 m cable (IP68 spotlights and IP67 connection technology for temporary submersion)
- **Smart control:** Select colours and set the timer using the OASE Switch controller and a smartphone or tablet (controller and power supply required, not included)
- **LunAqua Connect:** Modular lighting system for gardens and ponds that can be expanded at any time thanks to an extensive accessory range consisting of extension cables and distributors



Available from the second quarter of 2024



PRODUCT	LUNAQUA CONNECT M SOLO RGB
Dimensions (Ø x H)	61 x 98 mm
Rated voltage (primary, secondary)	230 V AC/24 V DC
Lamp power consumption	7.5 W
Energy efficiency class of lamp ^{*1}	G
Warranty ^{**131}	2 + 1 years
Luminous flux	217 lm
Item no. (GB Version)	
Item no.	74336

LUNAQUA CONNECT – THE FLEXIBLE MODULAR SYSTEM FOR GARDENS AND PONDS

LunAqua Connect Solo white

- **Flexible use:** Warm white lights for operation under and above water with 3 m cable (IP68 spotlights and IP67 connection technology for temporary submersion)
- **Smart control:** Option to select colours and set the timer using the OASE Switch controller and a smartphone or tablet (controller and power supply required, not included)
- **LunAqua Connect:** Modular lighting system for gardens and ponds that can be expanded at any time thanks to an extensive accessory range consisting of extension cables and distributors



Available from the second quarter of 2024



PRODUCT	LUNAQUA CONNECT S SOLO WHITE	LUNAQUA CONNECT M SOLO WHITE	LUNAQUA CONNECT L SOLO WHITE
Dimensions (Ø x H)	53 x 87 mm	61 x 98 mm	61 x 98 mm
Rated voltage (primary, secondary)	230 V AC/24 V DC	230 V AC/24 V DC	230 V AC/24 V DC
Lamp power consumption	2.5 W	4 W	6.5 W
Energy efficiency class of lamp ^{*1}	G	G	G
Warranty ^{**131}	2 + 1 years	2 + 1 years	2 + 1 years
Luminous flux	150 lm	250 lm	500 lm
Item no. (GB Version)			
Item no.	87020	87019	87022

^{*1} Further information on the energy efficiency class on page 128.

^{**2} Suitable for temporary submersion, e.g. due to rainfall, in puddles or for burying

LunAqua Terra LED

- **Waterproof in accordance with protection class IP68:** No water entry possible! Thanks to the high-quality design according to protection class IP68, the lamp is suitable for permanent, safe operation above and under the water (connection: IP44)
- **Included:** Six-way distributor and low-voltage plugin transformer (sets)
- **Robust and economical:** Traversable, energy-efficient LED light
- **High quality:** Made from shiny stainless-steel material
- **Easy clip:** With a stainless steel clip for mounting in a 40 mm hole – no sleeve required
- **Warm white:** LED light with pleasantly diffused warm white light



PRODUCT	LUNAQUA TERRA LED SET 6	LUNAQUA TERRA LED EXTENSION CABLE
Dimensions (Ø x H)	45 x 15 mm	–
Rated voltage (primary, secondary)	230 V/50 Hz, 12 V/AC	12 V/AC
Lamp power consumption	0.25 W	–
Energy efficiency class of lamp ^{†1}	G	–
Weighted energy consumption per lamp	1 kWh/1000 h	–
Power cable length	10.00 m	10.00 m
Warranty ^{†2,131}	2 years	2 years
Item no. (GB Version)	Not available in GB	
Item no.	50729	51057

RADIANT LED ILLUMINATION FOR SPRING STONES

LunaLed

- **Flood light:** Beam angle of the LED: 72°
- **Included:** Low-voltage plug-in transformer included in the scope of delivery
- **Waterproof:** Protection class IP68 – suitable for permanent underwater use
- **Simple to install:** The innovative hose connector makes it possible: Simply feed the mains cable through the opening – it is not necessary to thread it through the entire length of the hose
- **Cool light:** With six or nine cold-white LEDs

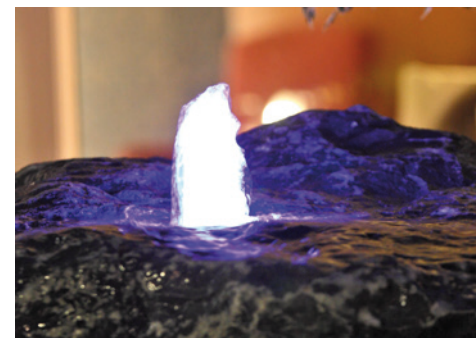
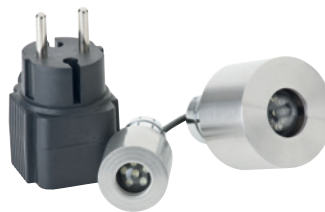

PRODUCT	LUNALED 6S	LUNALED 9S
Dimensions (Ø x H)	30 x 70 mm	50 x 70 mm
Rated voltage (primary, secondary)	230 V / 50 Hz, 12 V/DC	230 V / 50 Hz, 12 V/DC
Lamp power consumption	< 1 W	< 1 W
Energy efficiency class of lamp ^{†1}	G	G
Weighted energy consumption per lamp	1 kWh/1000 h	1 kWh/1000 h
Power cable length	10.00 m	10.00 m
Warranty ^{†2,131}	2 years	2 years
Inlet connections	19 mm (¾")	25 mm (1")
Item no. (GB Version)	Not available in GB	
Item no.	50114	50115

^{†1} Further information on the energy efficiency class on page 128

SMALL AND COMPACT WITH HIGH LUMINOSITY

LunAqua Power LED

- **Robust:** Spotlights, drivers and cables can be safely used in water up to 4 m deep (in accordance with standards, it is not possible to use the driver underwater in swimming ponds)
- **Upgradable:** A 10 m cable is available as an accessory to extend the distance between the light and the driver (max. 4x per line)
- **Highlight:** Bright light with low power consumption: One of the brightest LED spotlights in the OASE pond lighting range
- **Efficient:** As bright as a 50 W incandescent lamp with a power consumption of only 5.8 W
- **Durable:** The excellent thermal management and the high LED quality enable a service life of more than 36,000 hours
- **Compact:** Attractive small spotlight with robust underwater connection technology
- **Safe:** Also suitable for use in swimming ponds thanks to its low voltage (24 V DC)
- **Expandable:** Up to four lights per set with the separately available LunAqua Power LED W



PRODUCT	LUNAQUA POWER LED SET 1	LUNAQUA POWER LED SET 3	LUNAQUA POWER LED W	LUNAQUA POWER LED CABLE 10.0M
Dimensions (Ø x H)	80 x 117 mm	80 x 117 mm	80 x 117 mm	-
Rated voltage (primary, secondary)	230 V/50 Hz, 0-24 V / 350 mA/DC	0-24 V / 350 mA/DC	0-24 V / 350 mA/DC	0-24 V / 350 mA/DC / 700 mA/DC
Lamp power consumption	5.8 W	5.8 W	5.8 W	-
Energy efficiency class of lamp ^{†1}	F	F	F	-
Weighted energy consumption per lamp	7 kWh/1000 h			-
Guarantee (+ request guarantee) ^{†2,†3†}	2 + 1 years	2 + 1 years	2 + 1 years	2 + 1 years
Luminous flux	580 lm	580 lm	580 lm	-
Item no. (GB Version)	Not available in GB	-	-	-
Item no.	42633	42634	42635	42636

SIMPLE AND ECONOMICAL: CREATE A COLOURFUL LED SEA OF LIGHTS VIA APP

ProfiLux Garden LED RGB



- **Control a colourful sea of lights via app:** Colourful RGB effects are easily controllable via app with OASE Control
- **Want more?** ProfiLux Garden LED RGB is expandable by up to four lights per controller
- **Docking:** Directly compatible with light fixtures from the OASE Fountain Technology range
- **Thought of everything?** You will also need the following accessories: ProfiLux Garden LED controller, OASE Control connection cable, InScenio FM-Master Cloud
- **Patented:** Robust spotlight with protection class IP68 and OASE underwater connection technology
- **Robust:** Spotlights, drivers and cables can be safely used in water up to 4 m deep (in accordance with standards, it is not permissible to use the driver underwater in swimming ponds)

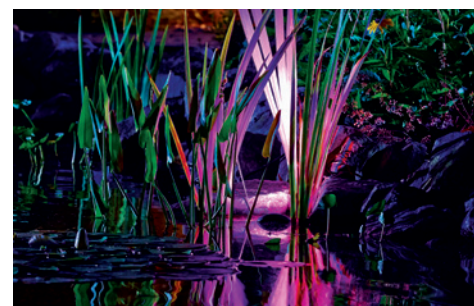

PRODUCT	PROFILUX GARDEN LED RGB	PROFILUX GARDEN LED CONTROLLER	PROFILUX GARDEN LED CABLE 7.5 M
Dimensions (Ø x H)	80 x 117 mm	210 x 109 x 69 mm	-
Rated voltage (primary, secondary)	24 V/DC	230 V/50 Hz, 24 V/DC	24 V/DC
Lamp power consumption	6 W (lamp)	30 W	-
Energy efficiency class of lamp ^{†1}	G	-	-
Weighted energy consumption per lamp kWh/1000h	7 kWh/1000 h	-	-
Luminous flux with all on	213 lm	-	-
Guarantee (+ request guarantee) ^{†2,†3†}	2 + 1 years	2 + 1 years	2 + 1 years
Item no. (GB Version)	-	-	-
Item no.	42638	42639	42640

* **System requirements:** A Garden Controller Cloud or InScenio FM-Master Cloud is required to use the OASE Control functions.

^{†1} Further information on the energy efficiency class on page 128

LunAqua Classic LED

- **Energy-saving:** Very energy efficient with a power consumption of only 1.3 watts per light
- **Eye-friendly:** LED light with pleasantly warm white light
- **Flexible:** Adjustable head for optimal beam angle direction
- **Radiant and bright:** A total of 120 lumens ensures particularly powerful illumination
- **Waterproof:** The light fixture is suitable for permanent use under water (protection class IP68, connection: IP44)
- **Wide beam angle:** Perfect for plants and other highlights in the pond and garden
- **Individual:** Adjustable head for flexible beam angle direction



PRODUCT	LUNAQUA CLASSIC LED SET 1	LUNAQUA CLASSIC LED SET 3
Dimensions (Ø x H)	75 x 114 mm	75 x 114 mm
Rated voltage (primary, secondary)	230 V/50 Hz, 12 V/AC	230 V/50 Hz, 12 V/AC
Lamp power consumption	1.3 W	1.3 W
Energy efficiency class of lamp ^{*1}	F	F
Weighted energy consumption per lamp	2 kWh/1000 h	2 kWh/1000 h
Warranty ^{*,131}	2 years	2 years
Luminous flux	120 lm	120 lm
Item no. (GB Version)	Not available in GB	-
Item no.	50527	50530

LunAqua 3 LED

- **Simple:** Quick plug 'n' play installation
- **Everything included:** Set contains 1 or 3 spotlights, 12 V transformer, rubber hose pipe, one or three pegs
- **High light:** Powerful 220 lumens for particularly bright illumination
- **Energy-saving:** Particularly energy-efficient with only 3 watts of power consumption
- **Wide illumination:** Ideal for flexibly configuring warm white light accents in the garden and pond
- **Waterproof:** Protection class IP68 – suitable for permanent underwater use (connection: IP44)
- **Flexible:** Adjustable head for optimal beam angle direction



PRODUCT	LUNAQUA 3 LED SET 1	LUNAQUA 3 LED SET 3
Dimensions (Ø x H)	75 x 140 mm	75 x 140 mm
Rated voltage (primary, secondary)	230 V/50 Hz, 12 V/AC	230 V/50 Hz, 12 V/AC
Lamp power consumption	3 W	3 W
Energy efficiency class of lamp ^{*1}	G	G
Weighted energy consumption per lamp	4 kWh/1000 h	4 kWh/1000 h
Warranty ^{*,131}	2 years	2 years
Luminous flux	220 lm	220 lm
Item no. (GB Version)	Not available in GB	-
Item no.	57034	57035



THE ULTIMATE CHOICE FOR NATURAL LIGHT

LunAqua Power LED XL



- **Colour design:** A colour temperature of 3000 Kelvin is well suited to showcasing red objects; lights with 4000 Kelvin are particularly suitable for emphasising green tones (bamboo, hedges etc.)
- **Durable:** The excellent thermal management and high LED quality enable a service life of more than 50,000 light hours
- **Thought of everything?** Accessories for an immediate start: LunAqua Power LED Driver with connection possibilities for up to four spotlights (2x LunAqua Power LED XL or 1x LunAqua Power LED XL and 2x LunAqua Power LED or 4x LunAqua Power LED)
- **Included:** 1 spotlight with 5 m cable and 1 peg
- **Individual:** Available in four different beam angles (Narrow Spot, Spot, Flood, Wide Flood)
- **Safe:** Also suitable for use in swimming ponds thanks to its low voltage (24 V DC)
- **Robust:** Spotlights, drivers and cables can be safely used in water up to 4 m deep (in accordance with standards, it is not permissible to use the driver underwater in swimming ponds)



PRODUCT	LUNAQUA POWER LED XL 3000 NARROW SPOT	LUNAQUA POWER LED XL 3000 SPOT	LUNAQUA POWER LED XL 3000 FLOOD	LUNAQUA POWER LED XL 3000 WIDE FLOOD	LUNAQUA POWER LED XL 4000 SPOT	LUNAQUA POWER LED XL 4000 FLOOD	LUNAQUA POWER LED XL 4000 WIDE FLOOD
Dimensions (L x W x H)	145 x 160 x 182 mm						
Rated voltage	24 V/DC	24 V/DC	24 V/DC	24 V/DC	24 V/DC	24 V/DC	24 V/DC
Lamp power consumption	15 W	15 W	15 W	15 W	15 W	15 W	15 W
Energy efficiency class of lamp ^{*)}	F	F	F	F	F	F	F
Weighted energy consumption per lamp	15 kWh/1000 h	15 kWh/1000 h	15 kWh/1000 h	15 kWh/1000 h	15 kWh/1000 h	15 kWh/1000 h	15 kWh/1000 h
Protection class	IP68	IP68	IP68	IP68	IP68	IP68	IP68
Cable length for 24 V device (with power supply unit)	5.00 m	5.00 m	5.00 m	5.00 m	5.00 m	5.00 m	5.00 m
Guarantee (+ request guarantee) ^{*)}	2 + 1 years	2 + 1 years	2 + 1 years	2 + 1 years	2 + 1 years	2 + 1 years	2 + 1 years
OASE Control connection	No	No	No	No	No	No	No
Bulb type	LED	LED	LED	LED	LED	LED	LED
Number of individual LEDs	8	8	8	8	8	8	8
Luminous flux	1250 lm	1250 lm	1250 lm	1250 lm	1350 lm	1350 lm	1350 lm
Luminous colour	Warm white	Warm white	Warm white	Warm white	Neutral white	Neutral white	Neutral white
Colour temperature	3000 K	3000 K	3000 K	3000 K	4000 K	4000 K	4000 K
Beam angle	10 degrees	15 degrees	30 degrees	45 degrees	15 degrees	30 degrees	45 degrees
Item no. (GB Version)	-	-	-	-	Not available in GB		
Item no.	51968	57763	57762	57764	51971	51969	51978

CONTROLS OASE CONTROL TECHNOLOGY BY APP OR COMPUTER

Garden Controller Cloud



- **OASE Control:** Up to ten OASE Control-enabled devices (pumps, filters, lighting) can be connected, controlled and monitored
- **Compatible with the app:** Simply download the OASE Control app (App Store or Play Store), register and get started*
- **Cloud-compatible:** Accessible worldwide via the free OASE Cloud
- **Year-round:** The housing is protected against splashing water (IP68) and can be operated outdoors all year round
- **Included:** Flexible mounting material for wall mounting or peg mounting included in the set

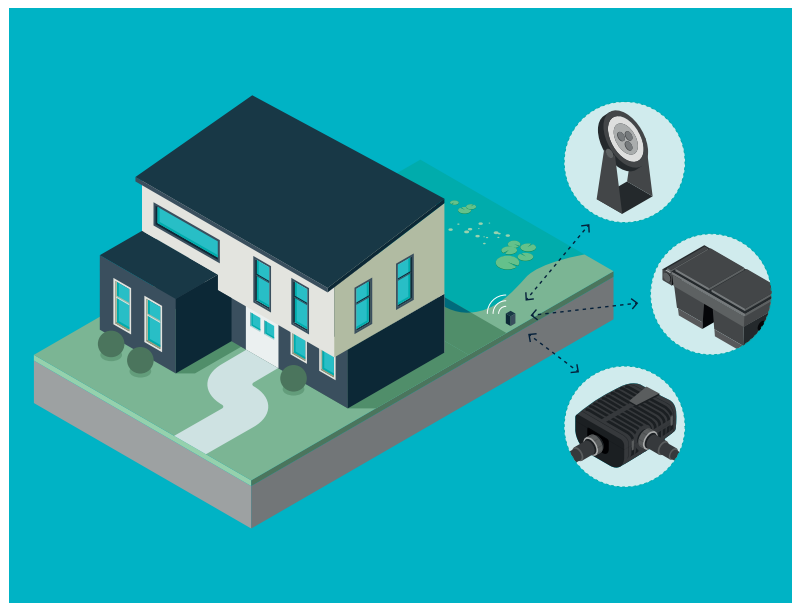

* **System requirements:** iOS 12.5 (Apple) or Android version 7.0 or later is required to run the app on mobile devices.

EXTRAS

RECOMMENDATION

The OASE Control app is compatible with iOS or Android mobile devices. As soon as updates that may be of interest to you are available, you will receive information about how to download these for free. To ensure the best possible Wi-Fi connection range (2.4 GHz) from the device or the router, make sure that the field of view between the smartphone/tablet and the Garden controller is clear. Commercially available repeaters can be used to extend the range further.

PRODUCT

GARDEN CONTROLLER CLOUD

Dimensions (L x W x H)	130 x 90 x 40 mm
Rated voltage	230 V / 50 Hz
Power consumption	4 W
Power cable length	2.00 m
Guarantee (+ request guarantee)*^{1p-131}	2 + 1 years
Wi-Fi range (2.4 GHz) max.	80.00 m
OASE Control connection	Yes
Network capability	Router/cloud
Wi-Fi hotspot	Yes
Item no. (GB Version)	-
Item no.	55317

GARDEN APP – FINALLY CONTROL YOUR TECHNOLOGY VIA WI-FI!

InScenio FM-Master Cloud



- **Innovative:** The true highlight of the OASE InScenio power management family, controllable via Wi-Fi or OASE Cloud via tablet or smartphone
- **Multi-connectors:** With four sockets: Three can be switched on and off, one can also be dimmed
- **Controllable:** Each socket has an integrated timer and can therefore be controlled 24 hours a day
- **Compatible with the app:** Simply download the OASE Control app (from the App Store or via GooglePlay) and get started*
- **OASE Cloud:** Accessible from anywhere in the world via the free OASE cloud
- **OASE Control:** Has an additional connection for connecting to OASE Control end devices
- **Multi-feature-compatible:** Up to 10 remotely controllable devices or OASE Control-managed devices can be integrated and controlled via the app
- **Year-round:** The sockets are protected from splashing water and can be operated outdoors all year round



* System requirements: iOS 12.5 (Apple) or Android version 7.0 or later is required to run the app on mobile devices.

EXTRAS

WI-FI CONNECTIVITY

Now the performance of your garden equipment can be read and controlled easily, conveniently and quickly via smartphone or tablet. And with a range of up to 80 m (with free signal transmission).



PRODUCT

INSCENIO FM-MASTER CLOUD

Dimensions (L x W x H)	215 x 155 x 295 mm
Rated voltage	220–240 V/50 Hz
Max. total load power	2700 W
Max. total load current	12.0 A
Guarantee (+ request guarantee) ^{7p-131}	2 + 1 years
Max. radio range (433 MHz)	80.00 m
Wi-Fi range (2.4 GHz) max.	80.00 m
OASE Control connection	Yes
Network capability	Router/cloud
Wi-Fi hotspot	Yes
Timer	Yes
Sockets on/off max. 2000 W	3 x 220–240 V
Sockets dimmable	1x max. 40–320 W
Item no. (GB Version)	70789
Item no.	70788

FLEXIBLE AND DECORATIVE POWER MANAGEMENT

InScenio



Sandstone-look cover



Splash protection



Main module



Remote control

- **Secure:** Guaranteed secure anchoring in the ground using the peg
- **Remote control:** The remote control supplied (apart from InScenio 230) has a range of up to 80 m provided that the radio transmission is uninterrupted
- **Simple to install:** Particularly simple and flexible installation without any groundworks



PRODUCT	INSCENIO 230	INSCENIO FM-MASTER 2	INSCENIO FM-MASTER 3
Dimensions (L x W x H)	215 x 155 x 295 mm	215 x 155 x 295 mm	215 x 155 x 295 mm
Rated voltage	220–240 V/50 Hz	220–240 V/50 Hz	220–240 V/50 Hz
Max. total load power	2700 W	2700 W	2700 W
Max. total load current	12.0 A	12.0 A	12.0 A
Warranty ^{p. 131}	2 years	2 years	2 years
Permanent sockets	4 x 230 V	1 x 220–240 V	1 x 220–240 V
Sockets on/off max. 2000 W	–	3 x 220–240 V	2 x 220–240 V
Sockets dimmable	–	–	1x max. 40–320 W
Item no. (GB Version)	Not available in GB		
Item no.	55433	36310	36311

A lush garden pond with tall grasses and a fountain. The pond is surrounded by dense green foliage and trees. The water is clear and reflects the surrounding greenery. A small fountain with multiple jets is visible in the lower right corner of the pond. The sky is blue with some clouds.

Pond construction



Further information
is available at:
[www.oase.com/en/
pond-construction](http://www.oase.com/en/pond-construction)

102 Pond construction

104 POND PLANNING AND IMPLEMENTATION

106 FLEECES & LINERS

108 PRE-FORMED PONDS

110 ACCESSORIES FOR POND PLANTING

112 POND EDGE SYSTEM AND BED EDGING

113 WATERCOURSE ELEMENTS

114 WATERFALLS

116 DECORATIVE ROCK-LIKE COVERS

117 WATER RESERVOIR

Pond construction at a glance



RECOMMENDATION

The movement of water through watercourses and waterfalls also supplies the pond with necessary oxygen. The material excavated from the garden pond can be used to create a watercourse or waterfall.

If possible, gradients in a watercourse should not be steeper than 40%.



WATERCOURSES (OPTIONAL)

When selecting the location for the watercourse, consideration should be given to different weirs, depths, as well as the largest possible overflows, so that additional movement and oxygen can enter the pond.



SWAMP ZONE

Ideal for lush embankment plants. It is between 10 cm above and below the water level.

SKIMMER



DEEP WATER ZONE

Here, filter pumps and watercourse pumps or, if necessary, pond drains are used.



SHALLOW WATER ZONE

Provides space for plants and microorganisms and thus makes an important contribution to the nutrient reduction in the pond. It is about 10–40 cm deep and should be as wide as possible.

FLOATING LEAF ZONE WITH E.G. WATER LILIES

THE CORRECT ORDER FOR LAYING A LINER:

1. Pond fleece
2. Pond liner
3. Stone liner (optional)

FILTER- AND WATERCOURSE PUMPS

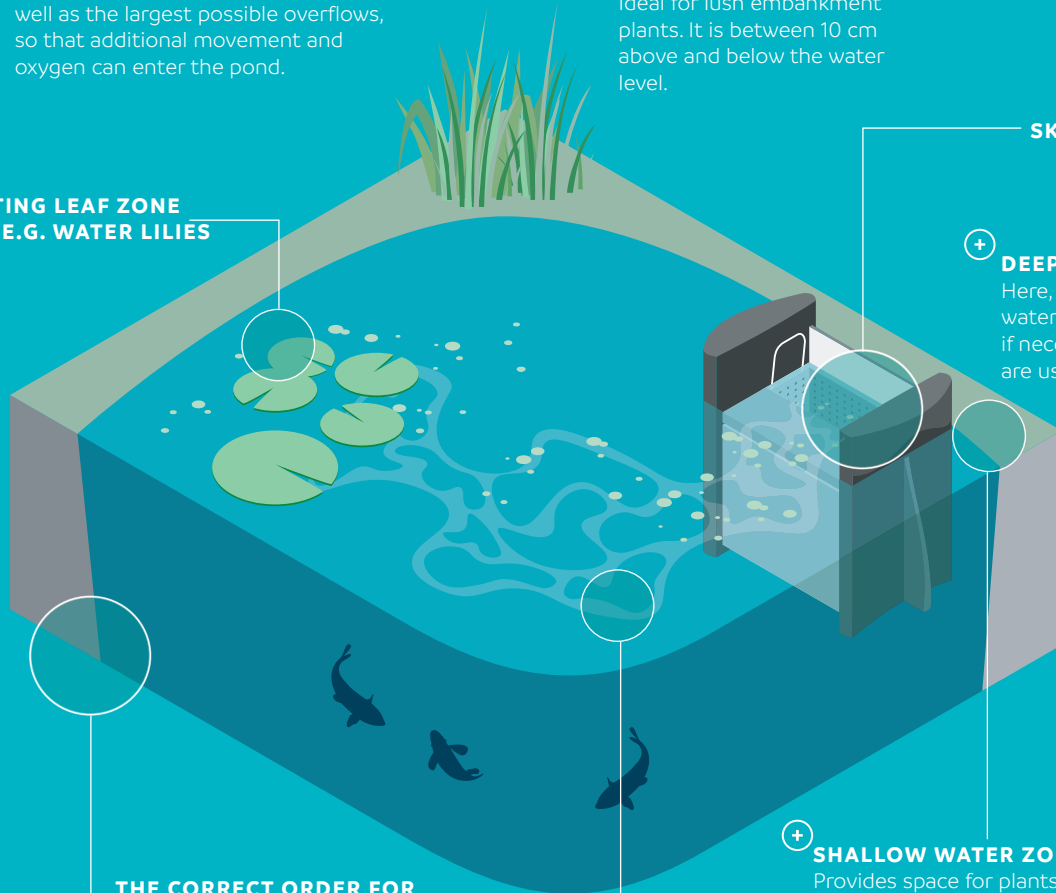

Step by step with products from OASE



1



2



3



4



5



6



7



8



9



10



12



11

1 Location: The right location for the garden pond should be semi-shaded; 4–6 hours of sunshine a day are ideal.

2 Pond outline: First, mark the pond outlines with sand. The various depth zones are also marked with sand.

3 Depth zones & pond edge: Shape the various depth zones with filling sand. You can then install the OASE pond edge system.

4 Measurement of liner and fleece: Then the required length of the fleece and the pond liner is generously dimensioned with a cord.

5 Fleece: After excavation, the trough is first lined with a fleece for protection against the penetration of roots and stones.

6 Liner and stone liner: The liner is then carefully laid. Stone liner is particularly suitable for a natural design at the edge area.

7 Planting of flat areas: Coconut mats are laid out for planting flat areas. They allow plants to optimally hold on with their roots.

8 Planting of steep areas: Steeper sections are planted with the help of embankment

bags. First, weigh these down with large stones, for example, to insert the plants.

9 Pond technology: Read the instructions for use when installing the OASE pond technology.

10 Pebbles and water: After the pebbles, the water goes in the pond: half of it first and it is only completely filled once the liner has completely settled.

11 Lighting: For an atmospheric ambience, it is a good idea to think about the appropriate lighting.

12 Done: The result can be seen.



EXTRAS

CALCULATION AID

How much liner is needed for a pond?

There are two formulas for calculating the liner:

Length + 2 x depth (at the deepest point of the pit) + 2 x 50 cm = length of the liner strip

Width + 2 x depth (at the deepest point of the pit) + 2 x 50 cm = width of the liner strip

RECOMMENDATION

Aggressive root penetration, such as with bamboo, can damage the pond liner. Therefore, make sure that strong-rooted plants are always planted with root protection liners and a rhizome barrier on the pond. We recommend that the planting is coordinated with a specialist retailer in advance.

LINER TYPES AND APPLICATIONS

Fleeces & liners

Liner as a base

Creating a liner pond offers an infinite number of creative possibilities. The larger or more demanding the pond, the thicker the liner should be.

Individual liner lengths from the roll can be quickly and easily connected using the appropriate OASE accessories.

They are available in different versions:

POND LINER

- **OaseFol**, **EuroFol** and **EasyFol** rubber liners are particularly stretchy, robust, flexible to lay and easy to work with. The environmentally friendly EPDM liners are particularly UV and ozone resistant. We provide a warranty (p. 131) of up to 20 years on our OaseFol, EuroFol and EasyFol EPDM liners.
- **AlfaFol** is a single-layer PVC liner and is available in four thicknesses and two colours. The plastic liner can be welded or glued and is characterised by an excellent price-performance ratio. Small damages, e.g. those caused by garden tools, can be repaired quickly and easily. We provide a 15 year warranty (p. 131) on our AlfaFol PVC pond liner.

SWIMMING POND LINER

- **SwimFol** is extremely durable and ideally suited for use in swimming ponds.

DECORATIVE LINER

- **Stone liner** is a robust decorative liner with a fleece coating that can be quickly and easily applied to the pond liner with UniFix+.

Pond fleece

The optimal protection for the pond liner

As a base for your pond liner, we strongly recommend that you use a pond fleece. It reliably protects the liner against damage caused by sharp stones, uneven areas and roots (warning: except for bamboo and aggressive roots, in which case a rhizome barrier must be used). For the edge area or for particularly rough surfaces, it is recommended to lay a double layer of fleece.

OASE offers three different fleece thicknesses: 200 g/m², 400g/m² and 500 g/m². The latter is suitable for pond liners subject to particularly heavy wear, such as those used in swimming ponds.

EXTRAS

We strongly recommend using a pond fleece to protect the liner from stones and roots.

ACCESSORIES

PROTECTIVE POND FLEECE

200 g/m²/ 2 x 5 m

Item no. 43334



PVC LINER REPAIR KIT

- High-performance underwater adhesive
- Fish and plant compatible

Item no. 50843



UNIFIX+ 290 ML CARTRIDGE

- High-performance universal adhesive
- Even works well under water

Item no. 57148



PVC LINER ADHESIVE

- Bonds all PVC liners quickly and easily
- For 1 m² area (250 ml)
- For 4 m² area (1000 ml)

Item no. 36861 (250 ml container)

Item no. 36862 (1000 ml container)

Not available in GB



TRADUX WALL AND LINER TRANSITION

- Inlet connections: 19/25/32/38/50 mm, ¾", 1" 1¼", 1½", 2"
- Cable cross-section: 3–9 mm²
- Suitable for pond liners, PE ponds or pre-formed ponds
- Secure and clean sealing on all level surfaces





Item no. 57154



PE pre-formed ponds

- **Simple:** The installation of pumps into the pre-formed pond is easy
- **Deep areas:** With zones of different depths for a wide range of flora and fauna
- **Integrated:** Swamp zone and plant zone
- **Pre-formed:** Plastic ponds in organic shapes for a natural appearance up to 1 m³



					
PRODUCT	PRE-FORMED POND PE 150	PRE-FORMED POND PE 250	PRE-FORMED POND PE 500	PRE-FORMED POND PE 750	PRE-FORMED POND PE 1000
Dimensions (L x W x H)	1.20 x 0.80 x 0.45 m	1.35 x 0.92 x 0.54 m	1.78 x 1.26 x 0.56 m	2.10 x 1.40 x 0.60 m	2.40 x 1.40 x 0.62 m
Net weight	2.50 kg	3.50 kg	8.50 kg	17.10 kg	19.00 kg
Warranty ^{pp. 131}	15 years	15 years	15 years	15 years	15 years
Description	<ul style="list-style-type: none"> • Pre-formed plastic ponds up to 1 m³ • Organic pre-formed ponds can be planted quickly and easily using the swamp and plant zones already integrated into the mould • Easy installation of pumps 				
Item no. (GB Version)	-	-	-	-	-
Item no.	36790	36767	36768	36769	36770

BLENDING IN SO NATURALLY





Pre-formed ponds Stonecor

- **Inspired by nature:** The unique design of the pre-formed ponds is modelled on the most beautiful lakes in the world
- **Natural beauty:** The pre-formed ponds are perfectly suited to nature and the garden in terms of their shape and material
- **Sustainable:** The material is environmentally neutral and biologically friendly
- **Don't throw it away:** The material is 100% recyclable
- **Organic colonisation:** In addition, the granular surface provides ideal conditions for the settlement of pond biology
- **Easy to install:** The pre-formed ponds have a high degree of stability
- **Winter-proof:** The pre-formed ponds are frost-proof
- **Quality:** Uniform material density across the entire pre-formed pond
- **Warranty:** A full 15 years
- **Simple:** Installation is easy thanks to pre-formed pond zones
- **Pre-formed:** Plastic ponds up to 2.5 m³



THE DEEP ZONES

	Small ponds D 60–93 cm	Large ponds D 100–110 cm
1	10 cm	12 cm
2	20 cm	25 cm
3	35 cm	35 cm
4	60 cm	80 cm
5	83 cm	110 cm

	 PRE-FORMED POND ARAL SEA BASALT	 PRE-FORMED POND LAKE CONSTANCE BASALT	 PRE-FORMED POND CHIEMSEE BASALT	 PRE-FORMED POND LAKE TITICACA BASALT
PRODUCT				
Dimensions (L x W x H)	2.28 x 1.81 x 0.86 m	2.80 x 1.70 x 0.95 m	2.76 x 2.14 x 1.15 m	2.97 x 2.28 x 1.16 m
Net weight	68.00 kg	86.00 kg	115.00 kg	144.00 kg
Warranty ¹²⁻¹³¹	15 years	15 years	15 years	15 years
Volume	1000 l	1300 l	2000 l	2500 l
Description	Basalt	Basalt	Basalt	Basalt
Item no. (GB Version)	Not available in GB			
Item no.	36995	36999	37003	36989

Planting baskets/pond figures



Planting baskets

ROT-RESISTANT PLANTING BASKETS MADE FROM ROBUST PLASTIC:

- Planting basket round 13 (L x W x H): 13 x 13 x 10 cm
Item no.: 52630
- Planting basket round 22 (L x W x H): 22 x 22 x 12 cm
Item no.: 52632
- Planting basket water lilies round 40 (L x W x H): 40 x 40 x 28 cm
Item no.: 54318
- Planting basket square 11 (L x W x H): 11 x 11 x 11 cm
Item no.: 53754
- Planting basket square 19 (L x W x H): 19 x 19 x 9 cm
Item no.: 52631
- Planting basket square 23 (L x W x H): 23 x 23 x 13 cm
Item no.: 52633
- Planting basket square 28 (L x W x H): 28 x 28 x 18 cm
Item no.: 53755
- Planting basket square 35 (L x W x H): 35 x 35 x 26 cm
Item no.: 54313
- Planting basket oval 45 (L x W x H): 45 x 18 x 15 cm
Item no.: 53756

Textile planting baskets

ROT-RESISTANT PLANTING BASKETS MADE FROM ROBUST TEXTILE:

- Textile planting basket round 15 (L x W x H): 15 x 15 x 15 cm
Item no.: 51189
- Textile planting basket round 25 (L x W x H): 25 x 25 x 25 cm
Item no.: 51190
- Textile planting basket square 18 (L x W x H): 18 x 18 x 18 cm
Item no.: 51191
- Textile planting basket square 25 (L x W x H): 25 x 25 x 20 cm
Item no.: 51201
- Textile planting basket square 30 (L x W x H): 30 x 30 x 30 cm
Item no.: 51203

Not available in GB

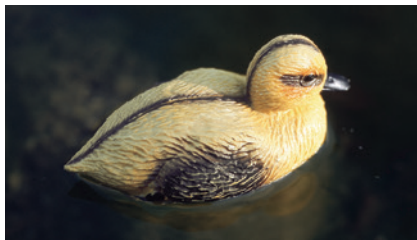

Pond figures

LIFELIKE EMBELLISHMENT OF THE POND LANDSCAPE

The heron model serves as effective protection against raiding herons, incl. peg

- Heron (L x W x H) 500 x 170 x 760 mm
Item no.: 36868
- Duckling (L x W x H): 130 x 70 x 75 mm
Item no.: 36863
- Male duck (L x W x H): 400 x 150 x 170 mm
Item no.: 36864, Not available in GB
- Female duck (L x W x H): 400 x 150 x 170 mm
Item no.: 36865, Not available in GB

EXTRAS

ACCESSORIES



Embankment mats

COCONUT EMBANKMENT MAT

- **Take it easy:** The OASE coconut embankment mat makes covering and planting pond bank areas simple and straightforward
- Sold off the roll
- Mesh width: 20 x 20 mm
- Dimensions (L x W): 20 x 1 m

Item no.: 53762

Not available in GB



Embankment bags

COCONUT EMBANKMENT BAGS

- **Optimal support:** A mesh size of 20 x 20 mm makes planting easy
- Dimensions (L x W): 100 x 80 cm



Item no.: 89622

Pond edge

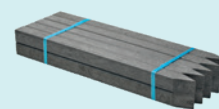
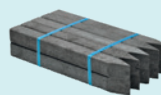

- **Practical:** Pegs in different lengths, suitable for different soil conditions
- **In good shape:** Gives a harmonious shape to the pond or stream
- **Multifunctional:** Also perfect as a plant bed border, lawn edge or patio boundary
- **Flexible:** Easily form any desired shape
- **Top edge:** Determines the subsequent maximum water level in the pond and forms a capillary barrier as the pond edge
- **Straightforward:** Easy to install
- **Tough:** The solid-material pegs are more warp resistant, making them easier to install even in hard ground

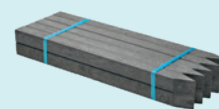

	 PRODUCT PONDEGE POND RIM 14 cm, 25 m	 PRODUCT PONDEGE POND RIM 19 cm, 25 m	 PRODUCT PONDEGE POND RIM 10 PEGS	 PRODUCT PONDEGE POND RIM 10 PEGS XL
Dimensions (L x W x H)	25,000 x 140 x 7 mm	25,000 x 190 x 7 mm	380 x 31 x 31 mm	580 x 31 x 31 mm
Colour	Grey	Grey	Grey	Grey
Warranty ^{p. 131}	2 years	2 years	2 years	2 years
Description	<ul style="list-style-type: none"> • Pond edge acts as a capillary barrier • Solid-material pegs are more warp resistant and are also easier to install in hard ground • Defines the subsequent maximum water level in the pond • Gives the pond a harmonious shape • Made from non-rotting recycled material, it is particularly durable 		<ul style="list-style-type: none"> • Insert a peg into the ground every 50 cm and secure the pond edge using screws or staples • Easy installation and quick assembly • Also ideally suited for use as lawn edging, a flower bed or terrace boundary 	
Item no. (GB Version)	-	-	-	-
Item no.	57751	57752	57753	57754

TRUE TO NATURE AND VARIABLE

Grand Canyon modular watercourse elements

- **Robust:** Weather-resistant polyresin
- **Stylish:** Integrates well into the general ambience thanks to its natural look
- **Included:** The elements are each equipped with 32 mm (1 ¼") threads, plugs and stepped hose sleeves
- **Bubbles:** Each watercourse element can also be used as a source
- **Unique:** High-quality colours, applied by hand

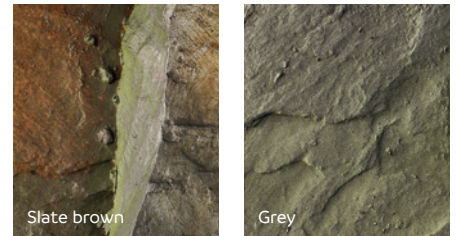
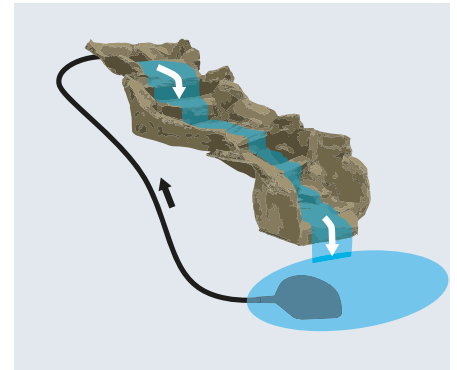

EXTRAS

RECOMMENDATION

The watercourse elements are ideal for creating a natural-looking flowing body of water in the garden. Each element can be used as a source: Simply drill through at the appropriate point – done!

						
PRODUCT	GRAND CANYON SLATE BROWN, RIGHT	GRAND CANYON GREY, RIGHT	GRAND CANYON SLATE BROWN, LEFT	GRAND CANYON GREY, LEFT	GRAND CANYON SLATE BROWN, CLIFF	GRAND CANYON GREY, CLIFF
Dimensions (L x W x H)	900 x 800 x 200 mm	900 x 800 x 200 mm	1000 x 900 x 150 mm	1000 x 900 x 150 mm	850 x 800 x 240 mm	850 x 800 x 240 mm
Net weight	5.40 kg	5.80 kg	5.50 kg	5.60 kg	8.00 kg	6.50 kg
Warranty ^{p. 131}	2 years	2 years	2 years	2 years	2 years	2 years
Stockist PU	1 PC	1 PC	1 PC	1 PC	1 PC	1 PC
Item no. (GB Version)	-	-	-	-	-	-
Item no.	33063	33064	33065	33066	33067	33068

Waterfall/XL



- **Want light?** Atmospheric waterfall lighting (optionally available) is easy to install – the clever light feed-through is already integrated
- **Extra length:** The 60 mm longer outlet is ideal for mounting on house walls and garden walls (Waterfall XL)
- **Details:** Ensures a smooth water pattern and a precisely flowing waterfall
- **Optional:** Can be installed recessed in the wall or simply screwed onto the wall
- **Included:** Includes a stepped hose connector (19, 25, 32, 38 mm) and an extra-flat plug
- **Material quality:** Compact and robust waterfall made of high-quality stainless steel 1.4401 (V4A)
- **Width selection:** The attractive waterfalls are available in three widths



EXTRAS

RECOMMENDATION

Use Waterfall Illumination to easily immerse each waterfall in warm and pleasant light.

ACCESSORIES

Waterfall Illumination 30^{*1}
 Waterfall Illumination 60^{*1}
 Waterfall Illumination 90^{*1}

Item no. 51205
Item no. 51209
Item no. 51980



LED waterfall lighting – for stylish accent lighting in the evening.



^{*p. 131:} Information about the warranty type and scope

TIP

To enjoy your waterfall for a long time, clean the stainless-steel surface regularly so that limescale and dirt do not build up.

PRODUCT	WATERFALL 30	WATERFALL 60	WATERFALL 90	WATERFALL 30 XL	WATERFALL 60 XL	WATERFALL 90 XL
Dimensions (L x W x H)	140 x 300 x 100 mm	140 x 600 x 100 mm	140 x 900 x 100 mm	200 x 300 x 100 mm	200 x 600 x 100 mm	200 x 900 x 100 mm
Net weight	1.60 kg	2.60 kg	6.00 kg	1.90 kg	3.40 kg	4.80 kg
Warranty^{*p. 131}	2 years	2 years	2 years	2 years	2 years	2 years
Suction-side connection	25 mm (1")	25 mm (1")	32 m (1 ¼")	25 mm (1")	25 mm (1")	32 m (1 ¼")
Item no. (GB Version)	-	-	-	-	-	-
Item no.	50704	50585	50706	70771	70772	70773

WATERFALL HEIGHT (WATERLINE)	WATERFALL 30	WATERFALL 60	WATERFALL 90	WATERFALL 30 XL	WATERFALL 60 XL	WATERFALL 90 XL
0.80–1.00 m	AquaMax Eco Aquarius Universal Premium 3500–4000		AquaMax Eco Aquarius Universal Premium 4000–5000		AquaMax Eco Aquarius Universal Premium 5000–6000	
0.40–0.60 m	AquaMax Eco Aquarius Universal Premium 2500–3000		AquaMax Eco Aquarius Universal Premium 3500–4000		AquaMax Eco Aquarius Universal Premium 4000–6000	
0.20 m	AquaMax Eco Aquarius Universal Premium 2500–3000		AquaMax Eco Aquarius Universal Premium 3500–4000		AquaMax Eco Aquarius Universal Premium 4000–6000	

IN A MODERN STAINLESS-STEEL DESIGN

Waterfall kit



- **Want light?** Atmospheric waterfall lighting (optionally available) can be easily installed – the clever light feed-through is already integrated
- **Straightforward:** It can also be installed in combination with a water reservoir and matching lid. Simply screw on the reservoir lid and decorate with gravel – and you're done!
- **Broad selection:** Waterfall stand in 30 cm or 60 cm width
- **Easy to maintain:** The removable back panel makes maintenance a breeze
- **Eye-catching:** Compact and robust waterfall with a base made of high-quality 1.4401 stainless steel (V4A)



PRODUCT	WATERFALL KIT 30	WATERFALL KIT 60
Dimensions (L x W x H)	145 x 305 x 600 mm	145 x 605 x 600 mm
Net weight	5.90 kg	12.50 kg
Warranty ^{p. 131}	2 years	2 years
Suction-side connection	25 mm (1")	25 mm (1")
Item no. (GB Version)	Not available in GB	
Item no.	70774	70775

Decorative rock-like covers

- **Attractive look:** Decorative cover with an appealing rock-like appearance, suitable for the OASE products FiltoClear, FiltoMatic CWS, BioPress as well as InScenio FM-Master
- **Concealed:** Hides the technical filter heads completely and, thanks to its rock-like appearance, fits attractively into the natural environment of the pond landscape
- **Sturdy:** Robust and made of weather-resistant material for a design with long-lasting appeal



PRODUCT	FILTO MATIC CAP CWS L	FILTO MATIC CAP CWS XL	FILTOCAP SAND	INSCENIO ROCK SAND
Dimensions (L x W x H)	450 x 450 x 300 mm	450 x 650 x 300 mm	570 x 570 x 320 mm	300 x 300 x 400 mm
Net weight	4.60 kg	5.26 kg	4.16 kg	2.30 kg
Warranty ^{10, 131}	2 years	2 years	2 years	2 years
For covering	FiltoMatic 7000, FiltoMatic 14000	FiltoMatic 25000	FiltoClear 3000–30000 (all sizes)	AquaOxy 4800, InScenio
Colour	Stone grey	Stone grey	Sand grey	Sand grey
Item no. (GB Version)	Not available in GB		-	-
Item no.	50268	50269	50420	50417

THE RIGHT SIZE FOR EVERY WATER FEATURE

Water reservoir

- **Integrated groove:** For ensuring cables are routed correctly
- **Central opening:** For hose routing
- **Load-optimised connection:** Of both pond components
- **Service opening:** With cover
- **Weather-resistant:** Against heat and frost
- **Open design:** Simplifies use with pump, distributors and hoses



4 PRODUCT	WATER RESERVOIR COVERS				DESCRIPTION
	WR-T 60	WR-T 80	WR-T 100	WR-T 125	
Suitable for water reservoirs	WR 60	WR 80	WR 100	WR 125	<ul style="list-style-type: none"> • GRP • Load-optimised connection of both pond components • Central opening for hose routing • Incorporated groove to ensure cables are routed correctly • 10-year warranty (p. 131) • From WR 80: Service opening with cover
Service opening with cover	no	yes	yes	yes	
Load capacity	300 kg	300 kg	300 kg	300 kg	
Colour	Stone grey	Stone grey	Stone grey	Stone grey	
Item no. (GB Version)	Not available in GB				
Item no.	37115	37116	37117	37118	

3 PRODUCT	SEALING SLEEVE TT ½"	SEALING SLEEVE TT ¾"	DESCRIPTION
Dimensions (Ø x H)	40 x 38 mm	45 x 39	
Hose connection	13 mm	19 mm	
Hose connection	½"	¾"	
For water column	6.00 m	9.00 m	
Item no. (GB Version)	Not available in GB		
Item no.	37122	37123	

2 PRODUCT	SUPPORT ELEMENT U-BASE	DESCRIPTION
Dimensions (L x W x H)	365 x 385 x 360 mm	
Load capacity	700 kg	
Item no. (GB Version)	Not available in GB	
Item no.	37234	

1 PRODUCT	WATER RESERVOIR				DESCRIPTION
	WR 60	WR 80	WR 100	WR 125	
Dimensions (Ø x H)	600 x 400 mm	800 x 406 mm	1000 x 406 mm	1250 x 406 mm	<ul style="list-style-type: none"> • LLD-PE, for spring stones and watercourses • Manufactured according to the latest state-of-the-art rotational moulding process and therefore meets the highest demands • Weather-resistant against the effects of heat and frost • Resistant against roots • Optimal distribution of lateral loads and material stresses • 10-year warranty (p. 131)
Volume	66 l	137 l	210 l	340	
Max. edge width	80 mm	80 mm	80 mm	80 mm	
Item no. (GB Version)	Not available in GB				
Item no.	37110	37111	37112	37113	



Good to know



Further information
is available at:
www.oase.com

128 Good to know

- 128 ENERGY EFFICIENCY CLASSES
- 129 WATERCOURSE DIAGRAM
- 130 FRICTION LOSSES
- 130 PRO PRODUCTS
- 131 OASE GUARANTEE



Energy efficiency classes

The European Union energy label provides information about the energy efficiency class of a lamp, i.e. how much energy the lamp consumes in relation to its light output, as well as other features of the product. This information is used to assign LED lamps an energy efficiency class from A to G.

For your reference, please find an overview of the energy efficiency classes of the OASE lighting range, as well as additional relevant information.

Item no.	Product	Catalogue page	Energy efficiency class	This lamp contains built-in LED bulbs	The bulbs in the lamp cannot be replaced.
51205	Waterfall Illumination 30	Page 122		X	X
51209	Waterfall Illumination 60	Page 122		X	X
51980	Waterfall Illumination 90	Page 122		X	X
87020	LunAqua Connect S Solo white	Page 101		X	X
87019	LunAqua Connect M Solo white	Page 101		X	X
87022	LunAqua Connect L Solo white	Page 101		X	X
74350	LunAqua Connect Starter Set Controllable	Page 100		X	X
50729	LunAqua Terra LED	Page 102		X	X
50114	LunaLed	Page 102		X	X
51968	LunAqua Power LED XL 3000 Narrow Spot	Page 106		X	X
57763	LunAqua Power LED XL 3000 Spot	Page 106		X	X
57762	LunAqua Power LED XL 3000 Flood	Page 106		X	X
57764	LunAqua Power LED XL 3000 Wide Flood	Page 106		X	X
51971	LunAqua Power LED XL 4000 Spot	Page 106		X	X
51969	LunAqua Power LED XL 4000 Flood	Page 106		X	X
51978	LunAqua Power LED XL 4000 Wide Flood	Page 106		X	X

Watercourse diagrams

How: Which pump is right for your watercourse?

These diagrams are recommendations to help you select the correct pump for your watercourse (average watercourse application). This includes an approx. 5 m hose with a diameter of 1 1/2" (with a pressure loss of about 0.15 m of water column).

As a rule of thumb, the following applies to determining the correct pump for a watercourse:

Width of watercourse in cm x 1.5 l/min. = output l/min.

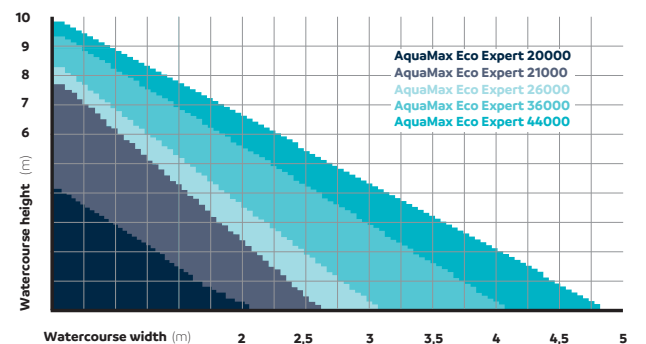
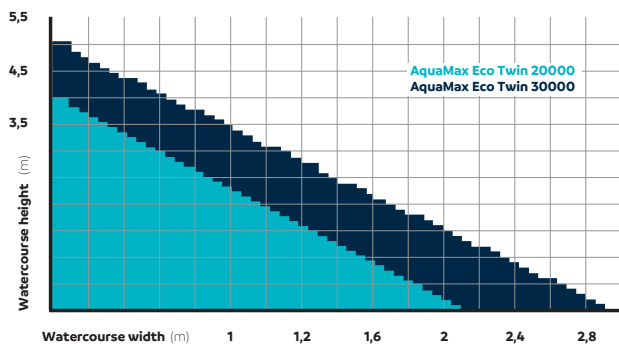
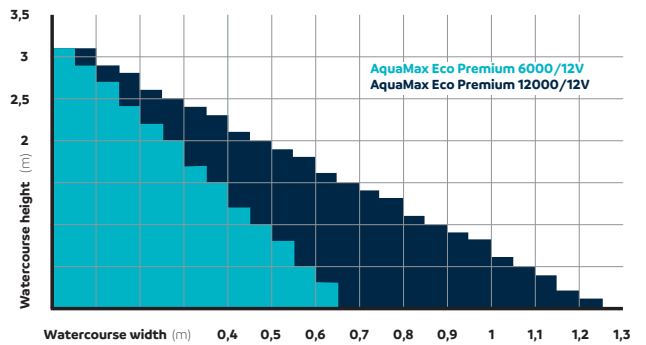
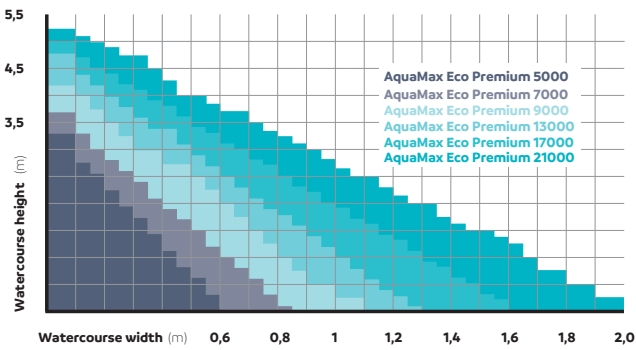
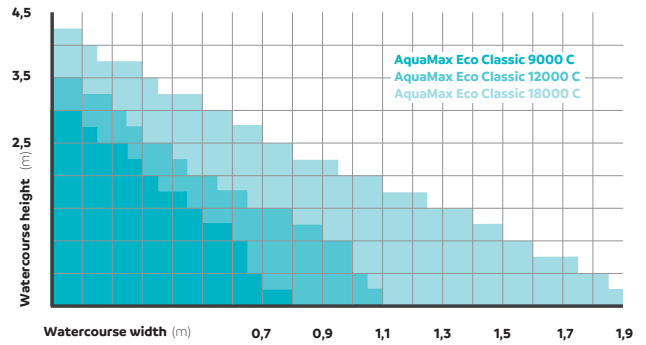
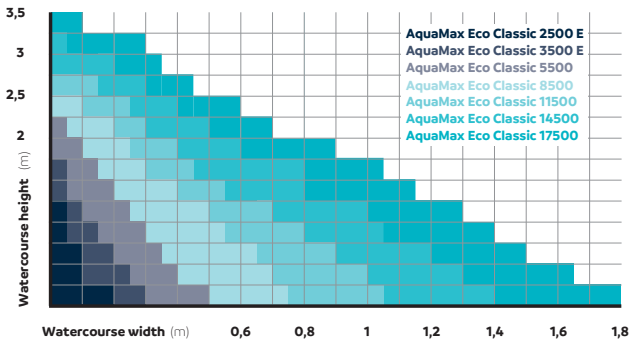
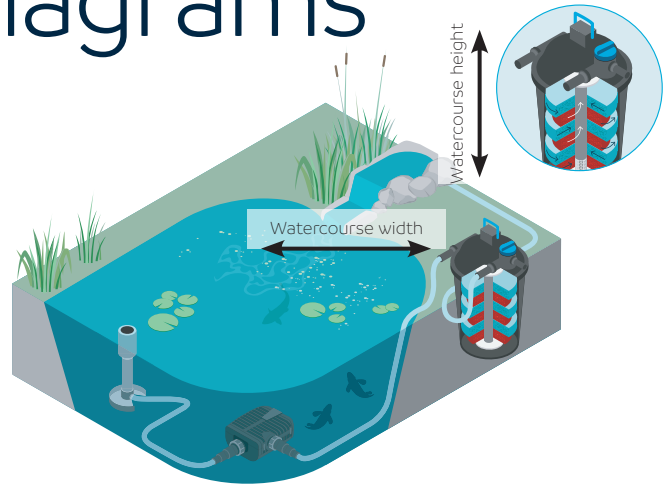

Friction losses in pipe and hose lines:

To make optimum use of the pump outputs, the hose diameter should be as large as possible. Too small a diameter or angle and flow restrictions due to hose connections influence the flow rate!

FLOW RATE (litres / min.)	LIGHT VALUES (mm / inch)	PRESSURE LOSS per running metre (mWC)
15 30	13 mm – ½"	0.34 mWC 1.20 mWC
30 50	19 mm – ¾"	0.12 mWC 0.32 mWC
50 75 100	25 mm – 1"	0.08 mWC 0.19 mWC 0.34 mWC
100 150	32 mm – 1¼"	0.11 mWC 0.21 mWC
100 150 200 250	38 mm – 1½"	0.03 mWC 0.07 mWC 0.12 mWC 0.15 mWC
200 250 300 350 400 450	50 mm – 2"	0.04 mWC 0.06 mWC 0.08 mWC 0.10 mWC 0.14 mWC 0.17 mWC

Notes

All values given for the fountain attachments are approximate. H = height in cm mWC = metre of water column Ø = diameter of the spray water in cm The spring diameters and spring heights may vary depending on the individual installation and the water quality.

Note: Electrical connection points must be at least 2 m away from the pond edge, dry and protected with a maximum 30 mA residual current protective device.

The products shown/offered are exclusively intended for the stated purpose. Catalogue pictures do not represent a product description in the sense of contractually owed properties. Minor variations from the products photographed do not constitute a defect. The publication of this catalogue renders all older catalogue versions invalid. Use of our image data is permitted only with prior written permission from OASE.

Our General Terms of Sale apply; these can be downloaded at www.oase.com.

PRO

All OASE products are developed and produced to the highest quality standards. For us, they are not just products – our aim is to combine innovative solutions, the highest quality and above all pure convenience in one product. And all this from a single source. We regularly analyse our products in our own test laboratory. We never compromise to ensure that we stay true to the OASE commitment to quality.

The products marked with **PRO** set new standards and form the latest generation of innovations. This helps you to find the most innovative OASE products at a glance. Our developers have equipped these products with special properties or made them even easier to use. Enjoy total convenience of the highest level.

Guarantee

Guarantee

OASE GmbH grants a manufacturer's guarantee under the conditions cited below; the guarantee period is designated on a productspecific basis. This is provided in the form of supplemental text with the product.

The designated guarantee period starts with the initial new product purchase from an OASE dealer. In the event of subsequent sale the guarantee period does not start over again from the beginning. The guarantee period is neither extended nor restarted through guarantee performances; legal guarantee claims do not occur on guarantee performances.

If the content of the guarantee is not otherwise specified separately, OASE grants a guarantee in the scope cited below: The prerequisite for claiming any guarantee from OASE, including the extension guarantee is that in the case of parts replacement /repair, the customer must have properly installed original OASE spare parts exclusively for any repair or remediation. Any OASE guarantee is invalidated if products from other manufacturers are used.

We provide guarantee performances, at our discretion, through no charge repair, or no charge delivery of original spare parts or of a replacement device of comparable value. If the type in question is no longer manufactured, we reserve the right, at our discretion to deliver a replacement device from our product line that is most like the original object of the guarantee claim. Reimbursement of expenses for removal and installation, inspection, claims for lost profit and compensation for damages are not covered by the guarantee, nor are more extensive claims for damages and losses, regardless of type, that have been caused by the device or its use.

The guarantee only applies for the country in which the product was purchased from an OASE dealer. German law applies for this guarantee in accordance with these conditions; with exclusion of the United Nations Convention on Contracts for the International Sale of Goods (CISG).

The legal rights of the purchaser, particularly arising from the warranty, continue in effect and are not limited by this guarantee.

Defects or damage that are due to faulty installation or operating errors, as well as insufficient care, or for example due to the use of unsuitable cleaning agents or neglected maintenance, non-intended use, damage, impact, the effects of freezing, etc. cutting off the plug, shortening the cable, calcium deposits or improper repair attempts, do not fall under the protection of the guarantee. With regard to intended use, we refer you to the user instructions, compliance with which is the basic prerequisite for a guarantee claim. Parts subject to wear, such as bulbs, are not part of this guarantee. If there is a guarantee case please contact your OASE dealer that sold the product to you.

If there is a guarantee case please contact your OASE dealer that sold the product to you. If this possibility does not exist, then claims arising from the guarantee can be made binding against OASE GmbH Tecklenburger Str. 161, 48477 Hörstel, Germany by shipping the device or the parts in question to us at your expense, together with the original purchase receipt of the OASE dealer, the guarantee certificate, as well as written information about the claimed defect.

A directory of OASE dealers is available at: www.oase.com

Extended Guarantee

Extended OASE Guarantee

Guarantee on request Based on the product, we extend our advertised manufacturer guarantee one time by 1 year, or alternatively by an additional 2 years of guarantee time in specially identified cases, under the same guarantee conditions in the special cases advertised by the manufacturer, and only on special request, this is done regularly only on request. We grant the extension guarantee only to end customers who have purchased the product from an OASE dealer and who do not commercially resell the product and install it on the premises of third parties in the course of their professional activities.

The term of the guarantee period starts with the expiration of the first guarantee, with the prerequisite that the product was verifiably purchased from an OASE dealer. Therefore in the event of resale the guarantee period does not begin at a later point in time, nor does it start over again. The guarantee period is neither extended nor restarted through guarantee performances.

At OASE's discretion the guarantee performance extends to free-of-charge repair of the defective part or replacement delivery of a comparable / equivalent value product with exclusion of more extensive claims. In addition, in a guarantee case, we shall accept the appropriate costs for sending in the defective product and the return delivery.

More extensive claims are excluded. The legal rights of the purchaser are not limited by this guarantee. The guarantor is **OASE GmbH, Postfach 2069, 48469 Hörstel, Germany** The extension guarantee can be acquired either through online registration or via the Hotline with submission of a copy of the original purchase receipt at: www.oase.com/en_GB/extended-guarantee **OASE-Hotline +44 (0) 1256 896886 (at the standard rate from the German landline network)** In the absence

of a deviating agreement, OASE collects your data exclusively for processing of the described guarantee, particularly for assurance of your identity and verification of the purchase object and the time of purchase. This data is used solely by OASE and is not disclosed to any third party.

Data protection

We use your personal data only to the extent required for execution and processing of the contract. Furthermore we would like to inform you of new products via regular mail, email, telephone and fax. We will request your express consent in this regard at the appropriate point, to the extent necessary. You can notify us at any time if you

no longer want to receive such information by contacting us on our Hotline **+44 (0) 1256 896886**.

If you purchase goods from us, in the future we will send information emails to you for similar goods. Even if a consent is not required, at any time you can request that you no longer receive such information emails from us. In this regard please contact us via e-mail at info@oase.com. Otherwise please take note of our Data Protection Policy at www.oase.com/en_GB/privacy-policy



For more information, please visit
www.oase.com

The products shown/offered are exclusively intended for the stated purpose. Catalogue pictures do not represent a product description in the sense of contractually owed properties. Minor variations from the products photographed do not constitute a defect. The publication of this catalogue renders all older catalogue versions invalid. Use of our image data is permitted only with prior written permission from OASE. Our General Terms of Sale apply; these can be viewed and downloaded at www.oase.com.

63698/11-23 OA