



**TRADE
GUIDE**

CONSERVATORIES & SKYLIGHTS



illuminate your world

Luma aluminium flat rooflights

**Made-to-measure.
Easy to install.**

Luma flat rooflights are made to order in the factory, then delivered straight to site. They're easy to install, helping you complete the job quickly, with no fuss and no mess.



Slim
profile



Secured
internally



Double or
triple glazed



U-value as low
as 0.9



10-year
guarantee

To find out more please visit
deeplas.co.uk



Page 11

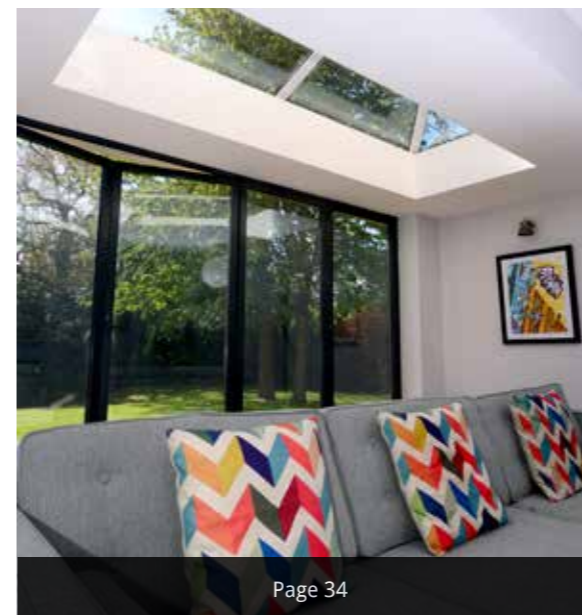

Page 34



Page 45

CONTENTS

Conservatory, orangery & roofing systems	4
Iconiq lantern roof	26
Skypod lantern roof	34
Skypod Plus lantern roof	38
Luma rooflight	44
Equinox	50

CONSERVATORY, ORANGERY & ROOFING SYSTEMS



SAVE TIME

- ▶ **Quicker & easier installation**
Easy and quick installation in just 2 days.
- ▶ **Quotes & amends in under an hour**
We aim to get quotes and amends back to you within the hour.
- ▶ **Flexible lead times to suit you**
Tell us when you need it and it will be there. Average delivery time of under 5 days.



SAVE HASSLE

- ▶ **On-site support for peace of mind**
Our qualified engineers can assist with surveys and on-site installation training.
- ▶ **Leading technical support**
A dedicated support network to assist you throughout the process.
- ▶ **Roofs delivered on time in full**
Last year over 99% of our roofs were delivered on time in full to our customers.

Contemporary or traditional, you can create desirable living spaces for your customers with our conservatory roof system

Impress customers and end-users with space-enhancing conservatories

Conservatories are the ideal way to extend any home, providing a bright, airy room that connects house and garden, giving busy households some valuable extra space. We offer a full range of conservatory roof systems, fully

compatible with all our high-performance doors and windows – enabling you to offer a complete conservatory fabrication and installation service for your customers. And with us, you can source all the doors, windows and roof components you need to create eye-catching conservatories.

Designed for faster, smoother installation

Designed with speed and ease of installation and fabrication, our conservatory roof, pilaster and highline gutter systems are one of the most advanced, user friendly systems on the market.



BESPOKE SOLUTIONS



WHY CHOOSE OUR ROOFS?

 <p>Designed for superior performance</p>	 <p>Fast, accurate installation</p>	 <p>Glass U-value as low as 1.0W/m²K*</p>	 <p>Variable pitches between 2.5 - 45°</p>
 <p>A choice of frame, glass and polycarbonate colours</p>	 <p>Available sprayed to any RAL colour</p>	 <p>Delivered in 5 working days*</p>	 <p>10-year guarantee</p>

Roofs to suit all building types – from traditional to contemporary

Whatever style, size or configuration of conservatory your customers require, we can supply the components to create the outdoor room of their dreams. Our bespoke conservatory solution enables you to fabricate any conservatory design, or you can choose from our range of classic styles, including Victorian, Edwardian, gable-ended and contemporary conservatories. For a more cost-effective, but equally high-quality conservatory, you can choose our lean-to style.

Bespoke designs to suit any property.

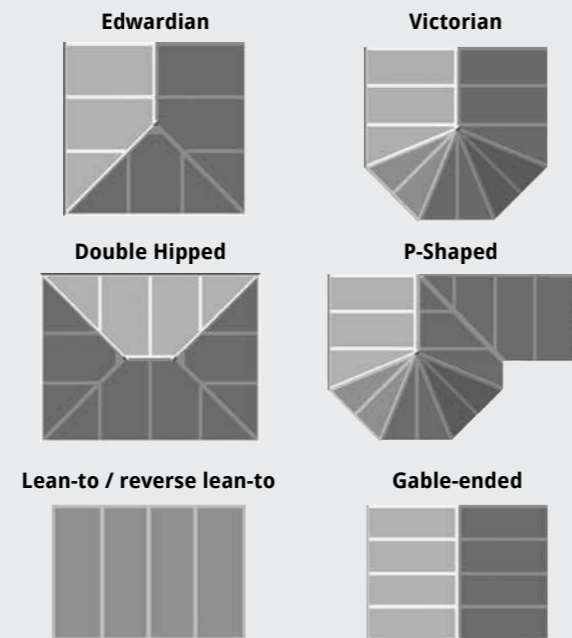

CONTEMPORARY CONSERVATORIES

MODERN SPACES FOR MODERN HOMES



A modern conservatory for the 21st century

Our latest contemporary conservatory design uses a combination of our exclusive pilaster system, our slimline roof system and our modern highline gutter to create a conservatory for the 21st century.

The pilasters consist of structural posts jointing standard window frames which are glazed with an insulating panel. The external is clad with either Coastline or Ecoscape cladding which are available in a range of colours. The internal can be either plastered or clad with a decorative panel.

Our conservatory roof system has been reinvented with thinner ridge system giving a more contemporary look to our latest roof system.

The highline gutter finishes the look, creating a stunning modern look on a conservatory which has a superior thermal performance allowing year round use.



MARKET-LEADING FEATURES



- ▶ Utilises window frame and insulation board creating a strong, well insulated construction.
- ▶ The pilasters can be clad externally with Coastline horizontal or Ecoscape vertical cladding options to give a modern, low maintenance finish.
- ▶ EWS120 PVC Corner Posts with EWS520A reinforcing give the conservatory a sturdy construction.
- ▶ No thin steel, aluminium or GRP trims which can be easily damaged.
- ▶ Internal finish can be easily plastered or cladded to suit the customers preference.
- ▶ Corner posts and 40mm in-line couplers allow installation of jacks if required.



- ▶ Allows you to create a more contemporary look to your conservatory design thanks to a thinner roof structure.
- ▶ Reduces sightlines for smaller conservatories.
- ▶ Maximum width 5.5m (based on 0.6 kn/m²)
- ▶ Ridge to wall flashing trim available in White and Anthracite Grey.



- ▶ Contemporary look which complements the Slimline conservatory roof.
- ▶ Powder coated Aluminium, available in White and Anthracite Grey.
- ▶ Suitable for internal and external 90 degree corners only.
- ▶ The vertical position of the gutter base allows easy installation onto full height brick walls without the requirement for additional cills, creating clean modern aesthetics.



TRADITIONAL

DESIGN CLASSICS FOR TIMELESS AESTHETICS

Turn back the clock with our classic conservatory collection

Our Victorian and Edwardian conservatory ranges give you a fast, easy fit with minimal gluing and sealing. And give your customers a bright, sunny extension to their living space with the charm and elegance of another age.

The extra finishing touches

Ornamental features like Jacobean or Regency finials and crests are a great way to add an extra flourish. Even structural components like box gutter supports can add to the ambience when you choose our decorative gallows brackets.

More colours to choose from

Along with the standard colour range of Brilliant White, Cream, Rosewood, and Golden Oak, our traditional conservatory systems also give you the option of four special colour specifications - Irish Oak, Black, Anthracite Grey and Chartwell Green - for even more choice and genuine period detail.

**FOR THE FULL COLOUR RANGE
PLEASE SEE PAGE 12**

Orangery Appeal

The Lusso system lets you create a faux orangery style roof to heighten the appeal of our Victorian, Edwardian and P- Shaped conservatories still further.

Available pre-fabricated or in kit form, it also brings an extra touch of elegance to the inside in the shape of a continuous box-section pelmet at the internal roof perimeter crests are a great way to add an extra flourish. Even structural components like box gutter supports can add to the ambience when you choose our decorative gallows brackets.

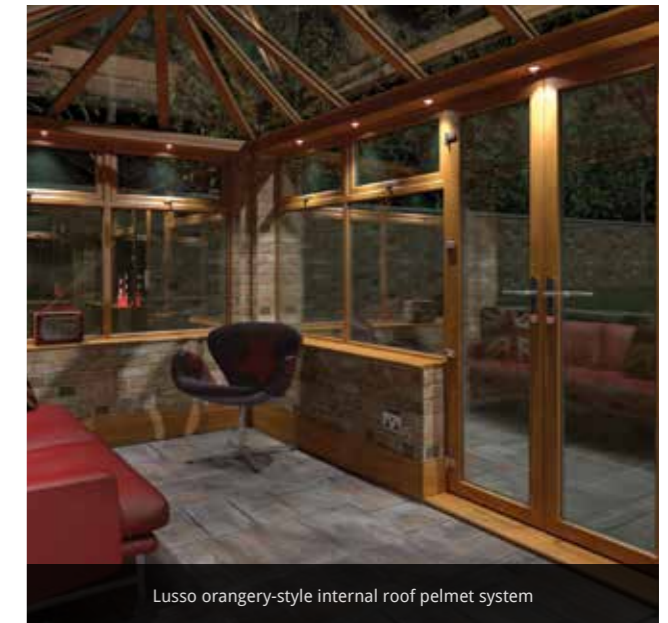

Lusso orangery-style internal roof pelmet system



COLOURS TO FRAME THE VIEW

COORDINATING WITH OUR RANGE

Colours to frame the view

A range of external colours (shown below) is available to complement your customers' existing windows and doors, as well as a choice of polycarbonate and glass options.

When required, our conservatory roofs can be specified with a complete range of fully foiled components. This includes foil finishes to the external ridge top capping, ridge ends, half ridge capping and valley capping – providing a unique and continuous finish. Aluminium foiled glazing bar top caps are also available.

The Pilaster system is available in a choice of 2 Coastline cladding and 3 Ecoscape vertical cladding options. These colours have been specifically selected to match and work with current conservatory colour trends.

Ten-year guarantee

Our conservatory roof system is guaranteed for ten years. That means you can give your customers the assurance of a robust, well-designed, precision-made product that's built to last – manufactured by the UK's leading PVC-U specialist.



TRADITIONAL, LUSSO & EQUINOX

PROFILE COLOURS



GLASS COLOURS



POLYCARBONATE COLOURS

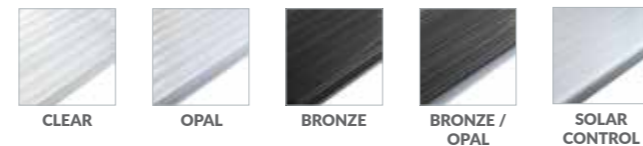

CONTEMPORARY CONSERVATORY

SLIMLINE ROOF COLOURS



PILASTER COLOURS



GLASS COLOURS

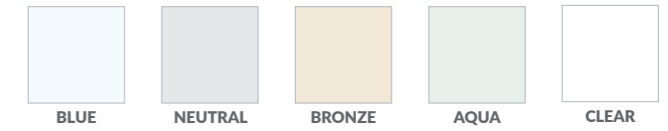

HIGHLINE GUTTER COLOURS



INTELLIGENT DESIGN

CREATES AN ADVANCED CONSERVATORY ROOF SYSTEM



Bottom caps in three pitch variants

Bottom caps are produced in three different pitch variants for maximum compatibility. This means that when installing or fabricating a standard 25° pitch conservatory, no cutting of the bottom cap is required.

Spider bars enable easy construction

Spider end mouldings allow all glazing bars fitted onto the front of the ridge to be square cut. These are factory fitted and slide into the end of the rafter bars ready to be hooked over the spider bar bracket, before the final tightening of the grub screw. This method of construction is quick, easy and reliable. To ensure optimum weather performance, a patented foam ridge end cover is also provided to minimise any reliance on silicone sealing.



Designed to make installation simple

All our conservatory roofs come well marked up and pre-drilled to make installation as simple as possible.



Box section eaves beam allows glazing pitches between 2.5-45°



Easy slide fixing for rafters



Silicone-free box-gutter adaptors



A variety of rafter bars

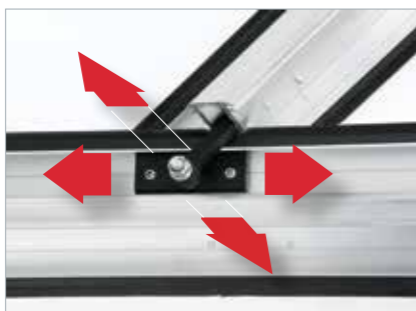

No-notch jack rafters can be 4-way adjusted on-site



Variable angle valley



A range of wall plates for flexibility



Virtually silicone-free ridge options



Patented ridge radius end assembly



Stainless steel tire wires offer a modern alternative to traditional tie bars



Leak-free and silicone-free box gutter adaptors



Sculptured eaves designed for greater consumer appeal

HIGHLINE GUTTER

CONTEMPORARY AND TRADITIONAL DESIGNS

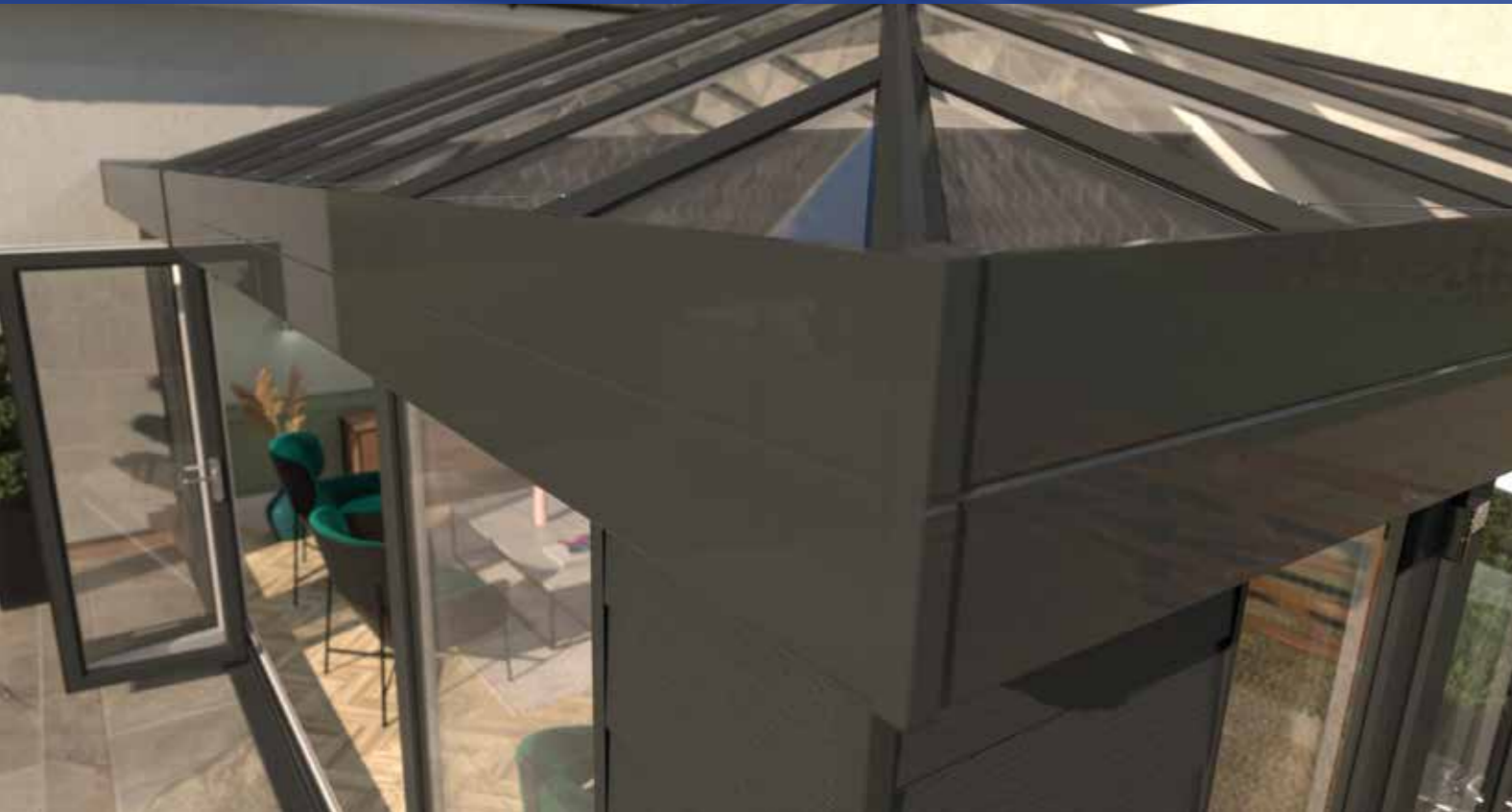

Contemporary Highline Gutter

This contemporary highline gutter is designed to make installation easier by allowing more room for installers to fix it to the conservatory. It is available in either White or Anthracite Grey. The bottom of the gutter is dropped when compared to our traditional highline gutter design for better aesthetics over full height brickwork and pilasters. It is only suitable for internal and external 90 degree corners.

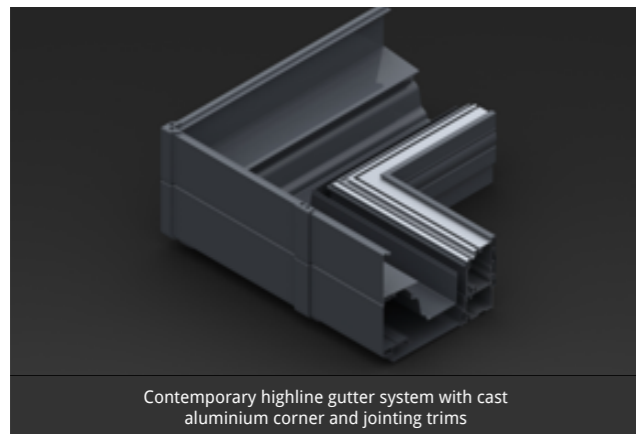

Contemporary highline gutter system with cast aluminium corner and jointing trims

Traditional Highline Gutter

Create the look of an orangery style conservatory with our quality highline gutter and decorative corner castings. This highline gutter design is perfect for conservatories or orangeries in a more traditional style.



INTERNAL PELMET

Internal plastered pelmet

Let the homeowner enjoy more natural daylight than from a clear glass lantern roof, plus a relaxing atmosphere created by concealed LED pelmet lighting in the evening.

Quick and easy to install

Lusso's clever box-section pelmet means there's minimal need for plastering required. Just clip interior trim and cladding direct to the aluminium frame. Faster, cleaner and less hassle than traditional orangeries.

Lusso Light PVC-U Pelmet

The intelligently-designed continuous box-section around the roof avoids the needs for plastering and simply allows the trims and cladding (all perfectly colour-matched to the orangery-style roof) to be fitted to the aluminium fascia mounted on brackets. As well as avoiding installers having to factor in specialist trades to carry out plastering, this design significantly reduces the amount of time needed to complete the project.

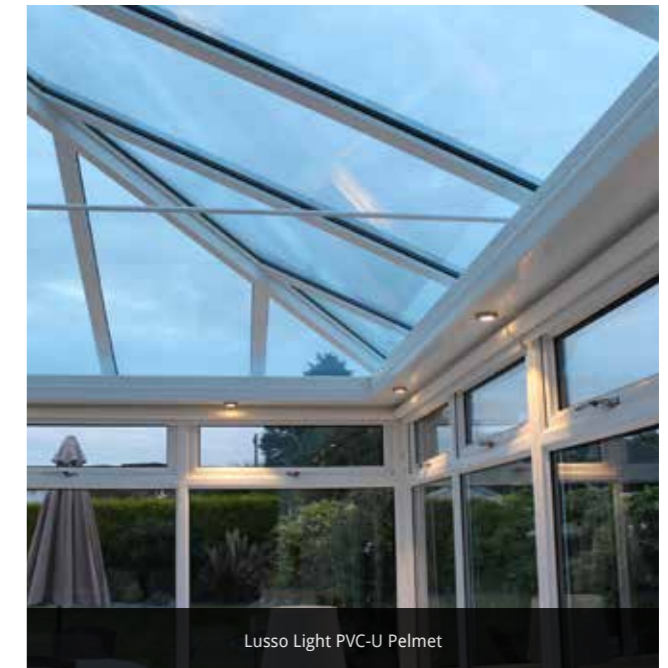

Lusso Light PVC-U Pelmet

Showing plastered internal pelmet



VARIABLE PITCHES

FOR ULTIMATE FLEXIBILITY

Eaves beam

Fixed 25° and variable 2.5-45°

Glazing pitches between 2.5° and 45° can be achieved from two box section aluminium eaves beams, designed to provide maximum strength and thermal efficiency.

The external front edge of the eaves beam is thermally clad in PVC-U, onto which gutter brackets are attached, which simply twist into place. These concealed brackets support a clip-fit dry joint gutter system which sits far enough forward to avoid any need for special running outlets and overcomes any risk of overflow leakage finding its way inside the conservatory.

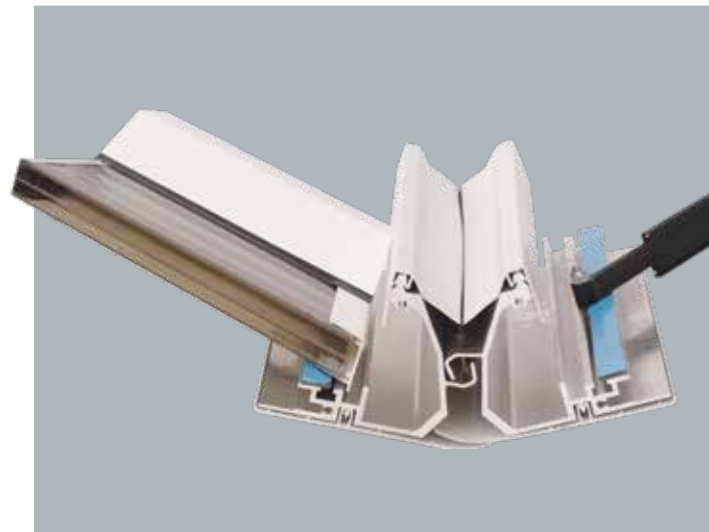
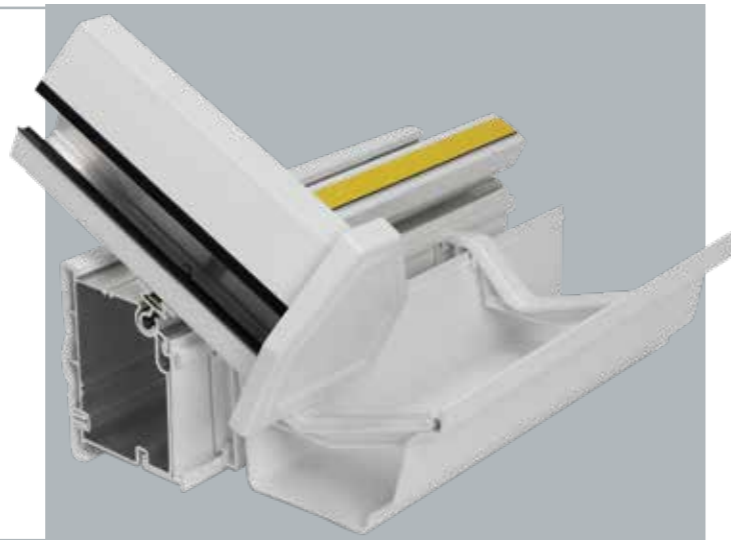

Valleys

Variable pitches

Our variable angle valley gutter system is able to accommodate a wide range of different pitch combinations, and allows secure and watertight installations for both glass and polycarbonate glazed roofs.

The system incorporates a glass retention system, and utilises high strength glazing tape.

The valley gutter system can also be used with drop valley situations and internal 135° corner situations.

Ridges

Fixed 25° and variable 15-45°

A fixed 25° or variable angle ridge body is available to accept roof pitches between 15° and 45°. They are designed to be virtually silicone-free, minimising the reliance on the fitter to obtain a water tight seal – making the roof quicker and easier to install.

Both designs accommodate 25mm and 32mm polycarbonate or 24mm glass units. The ridge top capping can be fitted prior to final glazing, allowing for easy on-site access for sealing and lead flashing work. Suitable ridge to wall flashing trims are also supplied as standard.

Finial and crestings slide along a captive rail, overcoming the need for fixings to pierce through the external ridge top capping – reducing the risk of water ingress. Ridge top caps are supplied fully foiled whenever woodgrain finishes are required.



Lean-to

Standard wall plates – 2.5-15°

The standard lean-to wall plate is a cost-effective solution for mono-pitch gable end lean-to conservatories. This system is suitable for pitches between 2.5° and 15°. A neat top cap detail allows for easy lead flashing and sealing.

Low-line wall plate – 2.5-5°

The low-line wall plate is designed to give extra flexibility for mono pitch designs where minimal roof height is imperative. The system eliminates the need for a PVC-U top cap, greatly reducing height. The system is suitable for pitches between 2.5° and 5°.

Half-ridge wallplates – 15-45°

A half-ridge wall plate is available for use with combination, P-shaped and hipped lean-to conservatory designs, and offers the same reliable, weather-tight seal as achieved with full ridges. Suitable for pitches between 15° and 45° using either polycarbonate or glass.



Deep skirt top cap

Where large pitch variance occurs on hip-ended roofs, a deep skirt top cap has been designed to ensure a neat and watertight finish can be achieved.

This allows the top cap to be cut to sit level on top of the glazing, either side of the hip.

BOX GUTTERS & ADAPTORS

CONTEMPORARY AND TRADITIONAL DESIGNS

Box gutters

The wide box gutter system provides space and access for fitting and maintenance. Cutting the box gutter to the external frame dimensions avoids any need to mitre across and over the top of window frames, minimising any risk of water ingress.

Strength is also one of the design features of the box gutter system. Combining it with the eaves beam section overcomes any need for additional strapping. In situations where the box gutter requires on-site jointing, running the eaves beam across the join locks the sections together to help minimise movement and risk to the seal joint.

Silicone-free box gutter adaptors (see **How It Works** opposite) can be installed in all weathers by simply clip-fitting the metal brace strap into position. This minimises the reliance on the installer and overcomes any need for heat guns, drying, or taping on-site. All box gutters are supplied with foam insulation to minimise the build up of condensation within the conservatory.

Raised back box gutter

Included within the box gutter range is a special dedicated raised back attachment and extension section that utilises the same variable support section as used around the eaves beam.

This provides full pitch flexibility and allows the same sealing method and system to be used. The result speeds on-site installation and ensures a neat final clad finish.

Joining box gutters

Occasionally, for either transport or access reasons, it is necessary to cut box gutters. Such box gutters then need to be mechanically rejoined on-site. In these cases, a factory welded insert simply slides into the adjoining section before sealing.

The insert helps keep box gutters together during installation and once installed minimises any movement to maintain a watertight joint. The ring beam then runs across the join to help lock each side of the box gutter together and minimise any subsequent movement.

HOW IT WORKS

BOX GUTTER ADAPTORS



Leak-free and silicone-free box gutter adaptors are unique to our conservatory roof system. The eaves beam runs along the inside face of the box gutter.

This allows the eaves beam to be mitre cut at corners without requiring any cutting to the box gutter, which can then be cut flush to the outside frame. This means water can only drain away to the outside of the conservatory.

The dry joint adaptor simply slides into place before being retained by a clip-fit steel brace. This results in a leak-proof all-weather installation solution, which is silicone-free.

Box gutter adaptor product chart

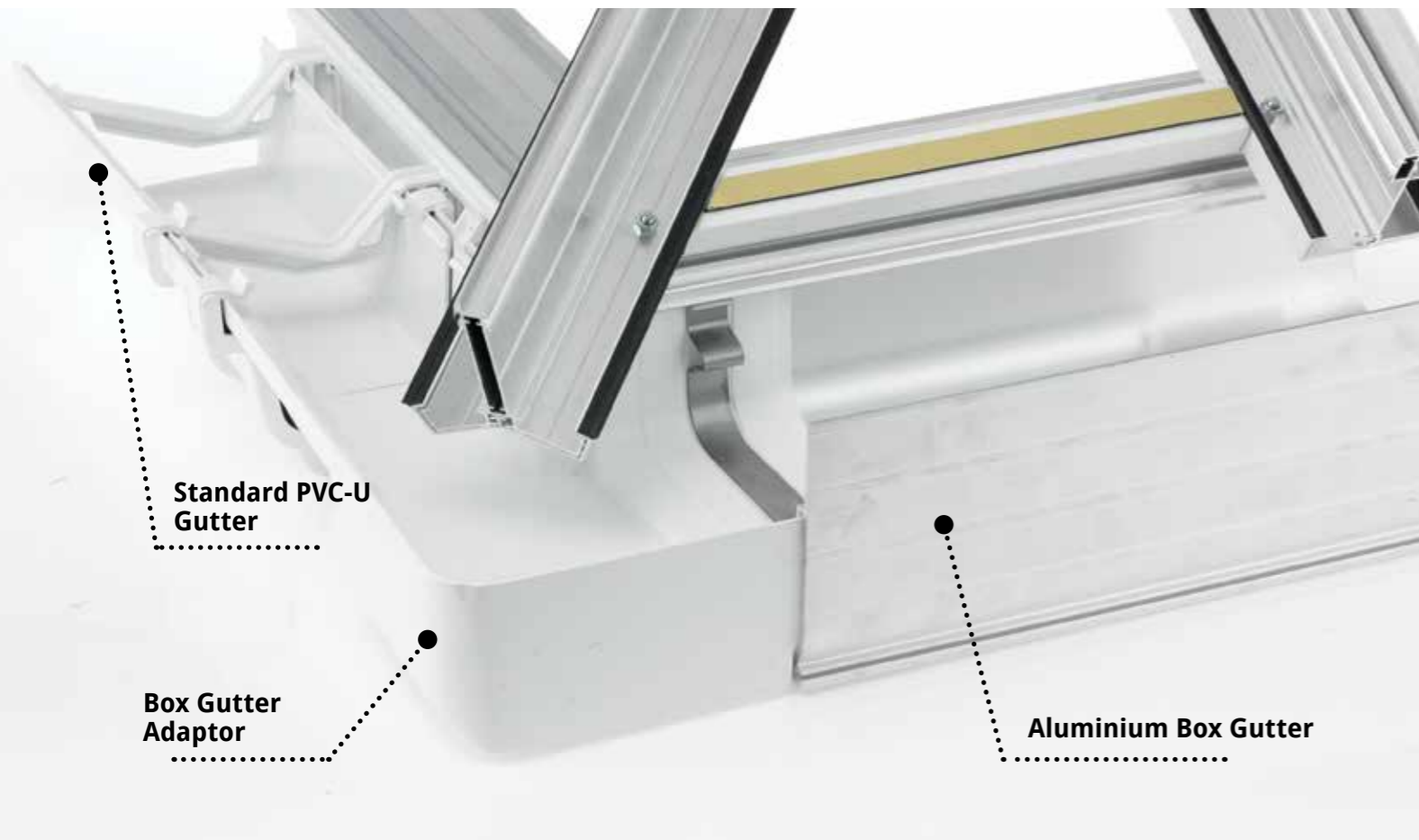
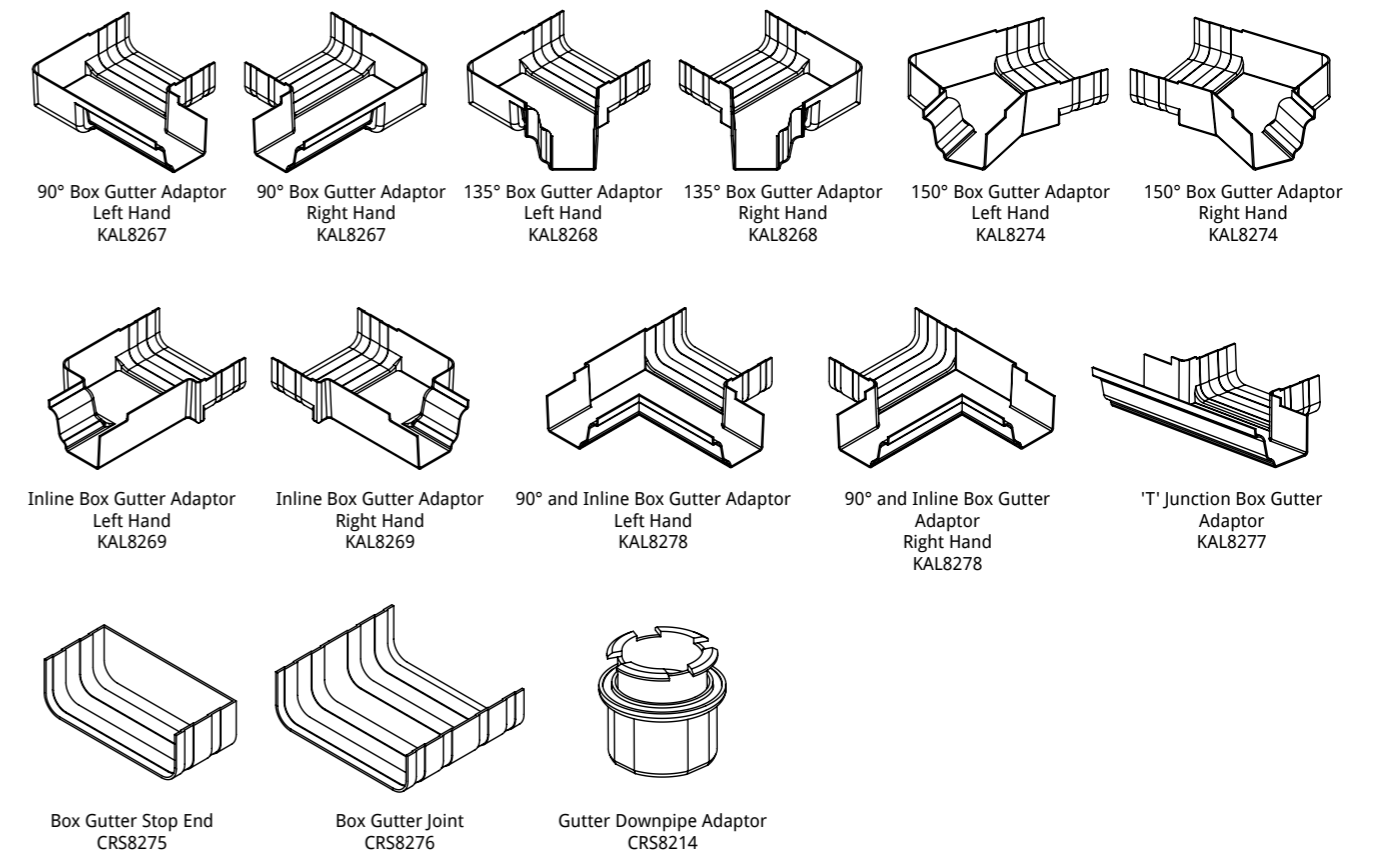

RAFTERS

GLAZING OPTIONS

HIGH STRENGTH GLAZING SOLUTIONS

GLASS AND POLYCARBONATE

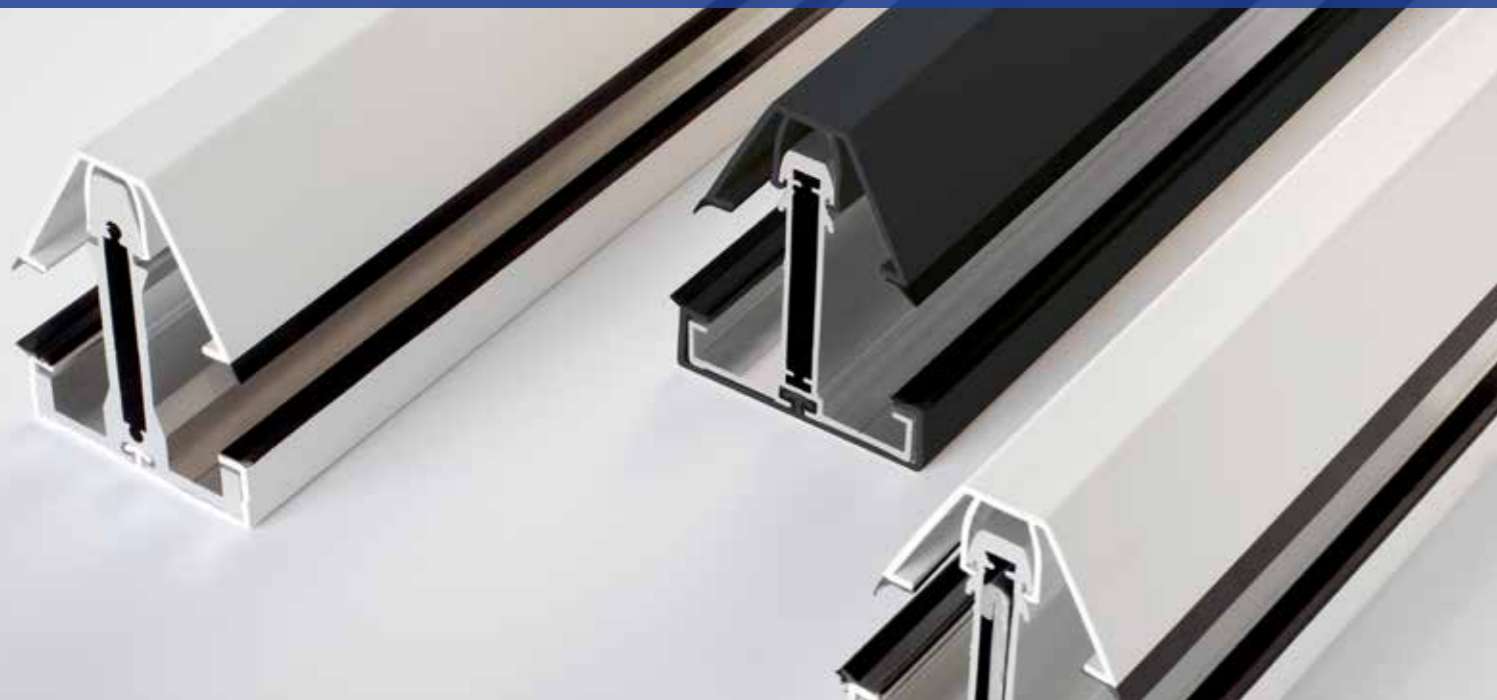

Heavy duty rafter bars

A purpose-designed range of heavy duty rafter bars can accept 25mm and 32mm polycarbonate or 24mm glass sealed units. All are supplied with glazing stops which are concealed behind special clip-up-and-over end caps. For greater spans, bars can be supplied with concealed steel reinforcement. A range of bolster bars (with dedicated end caps) is also available which can be fitted to the underside of the bars.

Gable rafter bars

Conservatory roofs which include wall-mounted gable rafters are supplied with an integral gutter channel as standard for neat and effective lead flashing.

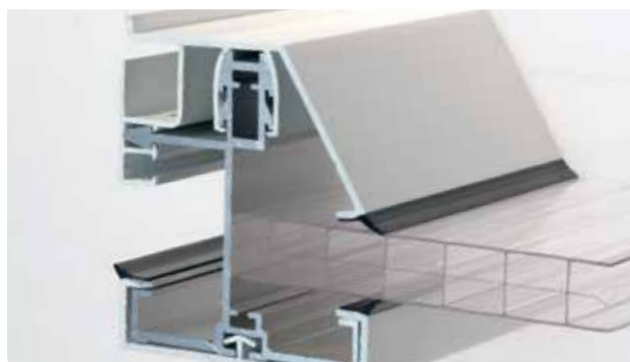

Gable rafter bars feature integral gutter system as standard

Jack rafters

Low-line easy-fit jack rafters require no notching. The assembly slides down the central chamber of the rafter bar to ensure a strong and secure fixing. Moveable fixing blocks link the hip bar to the jack rafter assembly. This simple design provides complete flexibility, enabling 4-way on-site adjustment if necessary.

Rafter fixing and end detail

Easy-slide single and double fixing studs are used to bolt rafters into position. They allow for easy movement and adjustment of the rafter bar before final positioning and fixing takes place. Simple and neat clip-up-and-over rafter end caps incorporate and conceal high-strength glazing end stops on the bottom of each bar.

LOOKING FOR A PREMIUM FINISH?

Optional aluminium top caps are available, featuring a PVC-U thermal break.

Glass

Suitability for glass roof glazing is a major feature of our roof system. Each glazing bar is supplied, as standard, with concealed high-strength glass end stops. This provides a safe buffer platform for units to rest against to overcome any risk of slippage, whilst the wide flat base of the eaves beam seal minimises any roll-out weakness between the bars.

We offer two glass types for conservatory roofs – standard toughened and high-performance Perfect Day glass.

The Perfect Day range of glass is available in a wide choice of performance and colour options, for maximum versatility and choice. The glass features a revolutionary dual-action self-clean coating as standard. Activated by sunlight and rain, the self-cleaning coat lasts the lifetime of the glass.

A solar control option is also available, which reduces heat build up without costly air conditioning.

Polycarbonate

A popular alternative to glass, multi-wall polycarbonate is available in a choice of colours and thicknesses, providing different levels of thermal efficiency to a conservatory roof.

This lightweight material offers extra heat and noise insulation, as well preventing glare.



ROOF HEIGHT CALCULATOR

GLAZING TYPES & PERFORMANCE

Roof height chart Apex roof designs with ridges

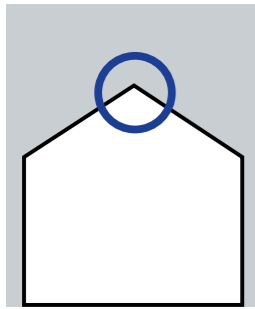

PITCH	WIDTH						
	2500mm	3000mm	3500mm	4000mm	4500mm	5000mm	5500mm
15°	588	655	722	789	856	923	990
20°	708	799	890	981	1072	1163	1254
25°	836	953	1069	1186	1302	1419	1535
30°	975	1119	1263	1408	1552	1696	1841
35°	1128	1303	1478	1653	1828	2003	2178

Height to bottom of ridge = less 173mm
For height including cresting allow a maximum of 170mm

Half ridge wallplate height chart Hip ended designs

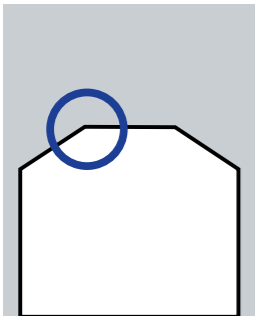

PITCH	WIDTH						
	2000mm	2250mm	2500mm	2750mm	3000mm	3250mm	3500mm
15°	789	856	923	990	1057	1124	1191
20°	981	1072	1163	1254	1345	1436	1527
25°	1186	1302	1419	1535	1652	1769	1885
30°	1408	1552	1696	1841	1985	2129	2274
35°	1653	1828	2003	2178	2354	2529	2704
40°	1931	1968	2351	2560	2770	2980	3190

Height to bottom of wallplate = less 173mm

Lean-to wallplate height chart Mono pitch designs

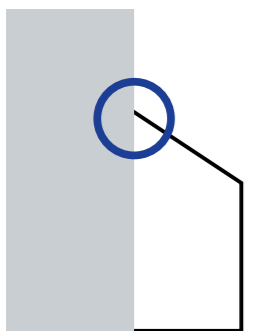

PITCH	WIDTH				
	2000mm	2500mm	3000mm	3500mm	4000mm
2.5°	360	382	403	425	447
5°	447	491	535	578	622
7.5°	535	601	667	733	799
10°	624	712	801	889	977
12.5°	715	826	936	1047	1158
15°	807	941	1075	1209	1343

Height to bottom of wallplate = less 192mm

Glazing type	Option	Colour	U-value	G-value	Light transmission	True self clean	Warm edge
Glass	Standard toughened	Clear	2.7	?	87%	?	?
Glass	Perfect Day Super 4s	Blue	1.0	28%	41%	3	3
Glass	Perfect Day Super 4s	Neutral	1.0	29%	37%	3	3
Glass	Perfect Day Super 4s	Aqua	1.0	22%	32%	3	3
Glass	Perfect Day Super 4s	Bronze	1.0	34%	42%	3	3
Glass	Perfect Day Super	Blue	1.2	40%	52%	3	3
Glass	Perfect Day Super	Neutral	1.2	40%	45%	3	3
Glass	Perfect Day Super	Aqua	1.2	28%	39%	3	3
Glass	Perfect Day Super	Bronze	1.2	49%	52%	3	3
Glass	Perfect Day Super	Clear	1.2	68%	78%	3	3
Glass	Perfect Day Clean	Blue	2.7	49%	59%	3	3
Glass	Perfect Day Clean	Neutral	2.7	47%	47%	3	3
Glass	Perfect Day Clean	Aqua	2.7	33%	40%	3	3
Glass	Perfect Day Clean	Bronze	2.7	46%	53%	3	3
Glass	Perfect Day Thermal	Blue	1.2	40%	52%	5	3
Glass	Perfect Day Thermal	Neutral	1.2	40%	45%	5	3
Glass	Perfect Day Thermal	Bronze	1.2	51%	54%	5	3
Polycarbonate	32mm 7 wall	Clear	1.4	53%	59%	5	N/A
Polycarbonate	32mm 7 wall	Opal	1.4	43%	11%	5	N/A
Polycarbonate	32mm 7 wall	Bronze	1.4	12%	13%	5	N/A
Polycarbonate	32mm 7 wall	Bronze / Opal	1.4	8%	15%	5	N/A
Polycarbonate	32mm 7 wall	Solar Control	1.4	4%	7%	5	N/A
Polycarbonate	25mm 5 wall	Clear	1.7	62%	62%	5	N/A
Polycarbonate	25mm 5 wall	Opal	1.7	39%	14%	5	N/A
Polycarbonate	25mm 5 wall	Bronze	1.7	21%	17%	5	N/A
Polycarbonate	25mm 5 wall	Bronze / Opal	1.7	19%	17%	5	N/A
Polycarbonate	25mm 5 wall	Solar Control	1.7	10%	7%	5	N/A

Note: The values shown above are provided for guidance purposes only, and are subject to variation caused by seasonal changes and other factors.

ROOF VENTS

For roof ventilation, roof vents can be incorporated into roof designs. Manual and electric designs are available, as well as a climate control system that automatically opens and closes the vent as temperatures rise or fall, or if rain is detected by an external sensor.

A REVOLUTION IN ROOF LANTERNS

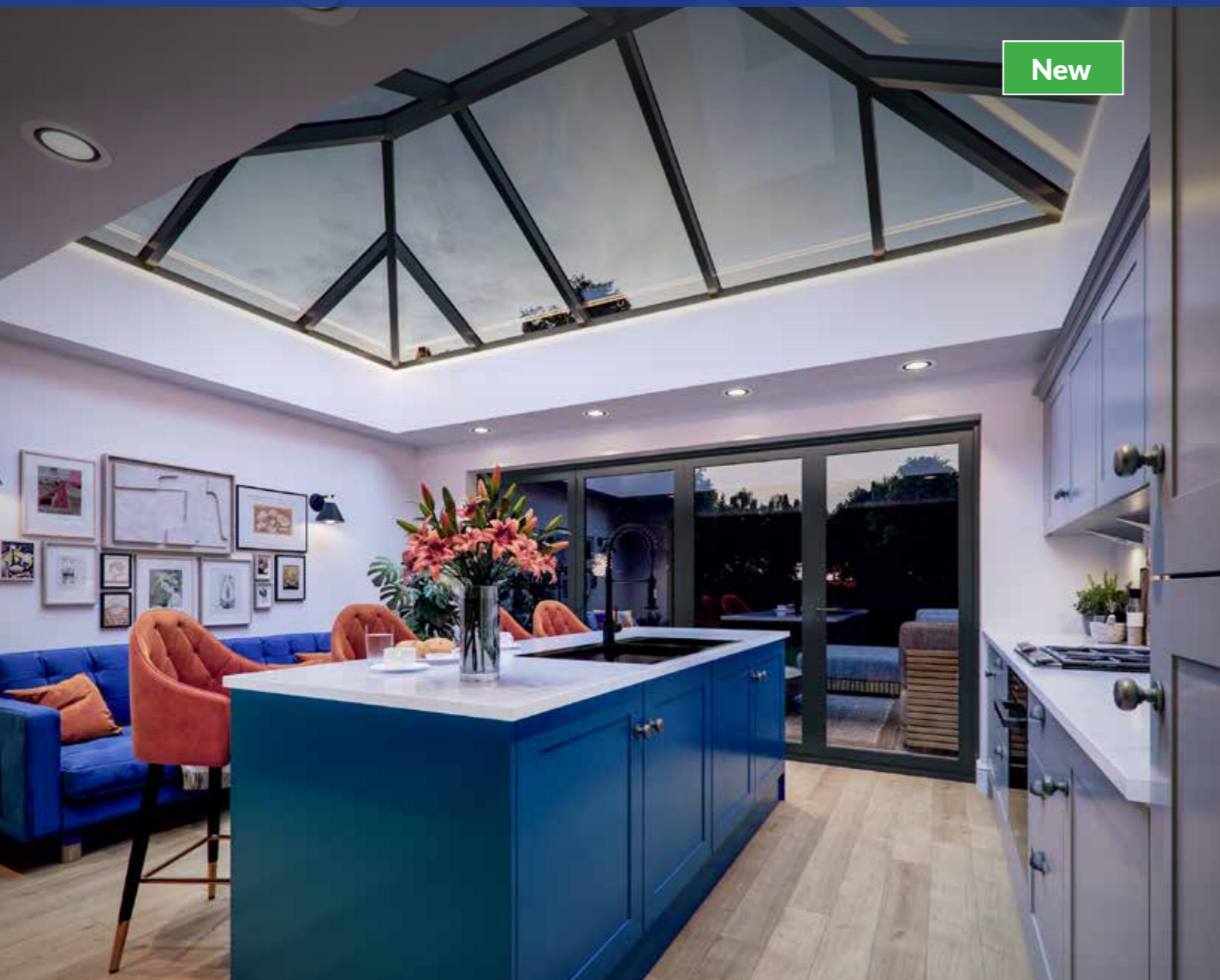

New

A revolutionary aluminium roof lantern designed to make your job easier and your work stand out.

Made from premium materials and offering the fastest installation time on the market, Iconiq helps you complete projects more quickly.

Built with installers in mind, it's efficient, durable and easy to fit – meaning less time on-site and fewer maintenance issues.

A high-quality product all round, Iconiq helps you win more work.

Plus, with its sleek design and exceptional performance, homeowners will love it too.



ICONIQ ROOF LANTERN

MEET OUR NEW ROOF LANTERN



OUR SERVICE PROMISE



Customer first
Whatever you need, we're here to help.



Fast quotes
Receive a detailed, personalised fast quote.



Technical support line
Need help? Our expert team is just a call away.



Assisted surveys
Need a site survey? We'll arrange for an engineer to assist.



Order checking
Every order is checked before delivery, so you can get straight to work.



Lead times to suit you
Tell us when you need it and we'll make sure it arrives on time.



Assisted installations
Need installation support? We'll arrange help on-site.



Always a solution
No matter the project, we have a roof lantern to fit.

THE Q-LOK ADVANTAGE

**Less time on-site.
Fewer headaches.
More jobs done.**

The Q-lok system **takes the hard work out of installation.** Fewer fixings. Perfect connections every time. The ring beam, hip beam, ridge beam, and rafters all click together with precision.



INSTALLATION IS EFFORTLESS

Thanks to the Q-lok system you can get it all done in **under 1 hour** and move on to your next job. No on-site drilling or silicone needed

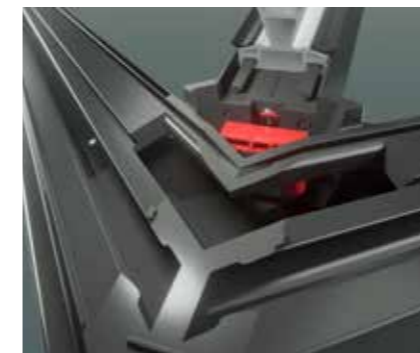

➤ **Rapid-fit slide & lock connections**

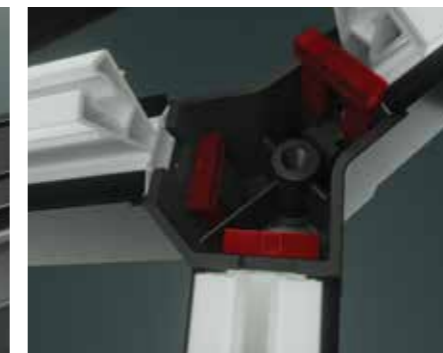

➤ **Fit together in seconds**

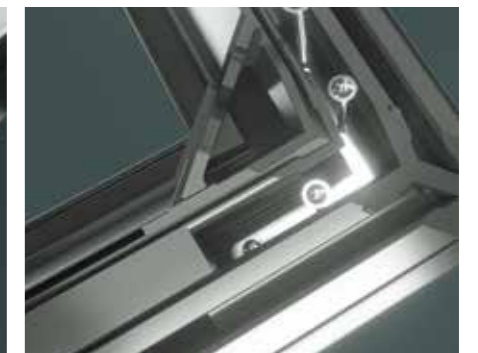

➤ **Minimal fixings**



Discover more

ICONIQ AT A GLANCE



Q-lok technology

Eliminates the need for mechanical fixings.

Made to measure for every project

Custom sizing ensures a perfect fit, with square and rectangular options up to 4m x 10m.* The largest spanning lantern on the market means you never have to turn down a project.

*Where the ridge length doesn't exceed 6m

Largest span

The strongest GRP ring beam on the market gives unmatched strength.



Secure & built to last

Internally fitted glazing clips and interlocking eaves create a strong, secure structure. Anti-tamper screws and tapered frame edges add extra security for your customers' peace of mind.

Fast quotes, short lead times

Fast quotes with lead times tailored to your schedule. Tell us when you need it, and we'll make sure it's ready and on-site.

10-year Guarantee

Built to last and backed by a decade of durability. Sell with confidence, knowing your customers are covered.



Integral drainage for zero hassle

A unique, purpose-designed system prevents water ingress via the crown moulding, reducing the risk of call-backs.

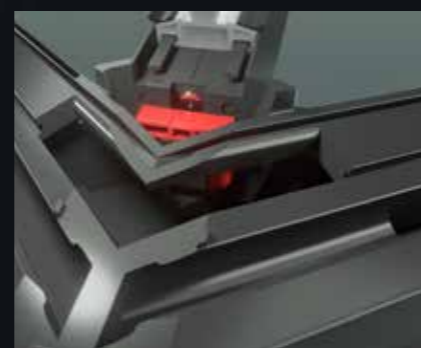

Slide & Lock

Precision connections fit together in minutes.



Minimal fixings

Simple installation.



Energy efficient by design

The GRP thermally efficient ring beam and patented Q-lok system create an insulating barrier, making this the most thermally efficient lantern on the market - another great selling point.

ICONIQ ROOF LANTERN

A SPECTRUM OF CHOICE



COLOURS FOR EVERY CUSTOMER



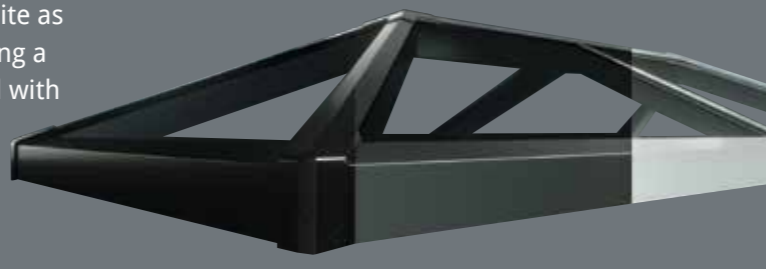

Available in Black, Anthracite Grey and White as standard. If your customers want something a little more bespoke, Iconiq can be sprayed with any RAL colour¹ and comes with a range of glass tint options.



FRAME COLOURS

	MATT BLACK RAL 9005		WHITE RAL 9003
	MATT ANTHRACITE GREY RAL 7016		ANY RAL COLOUR SPRAYED ²

GLASS OPTIONS

	CLEAR TOUGHENED OR LAMINATED		BLUE TOUGHENED OR LAMINATED
	NEUTRAL TOUGHENED OR LAMINATED		BRONZE TOUGHENED
	AQUA TOUGHENED		

Self-cleaning glass - Every Iconiq has a hydrophilic coating as standard so the glass stays clearer for longer

¹Additional charge and extended lead times apply.

SPANS THAT DEMAND ATTENTION

The strongest GRP ring beam on the market gives unmatched strength to weight ratio, creating the largest lanterns available on the market. You can take on bigger projects with confidence. More size options mean more opportunities to say yes to jobs, giving you greater flexibility and more satisfied customers.

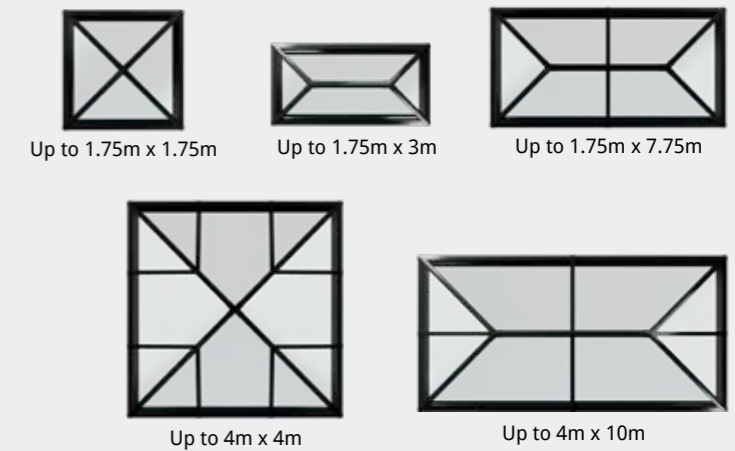

LED LIGHTING

The integrated LED lighting tray allows customers to add lighting to their lantern and create a perfect ambiance throughout the day.²

²Lighting not supplied.

LET THERE BE LIGHT

Iconiq boasts a contemporary streamlined design giving the perfect blend of architectural structure and sky views. A sleek 25° pitch floods spaces with natural light, creating a bright and airy feel your customers will love.



Self-cleaning glass

Whichever glass customers choose, every Aluna Iconiq has a hydrophilic coating as standard so the glass stays clearer for longer.



SKYPOD PITCHED LANTERN ROOF

WHY CHOOSE SKYPOD?

THERE ARE LOTS OF WAYS TO ADD LIGHT TO BUILDINGS, BUT NONE ARE AS STYLISH AS SKYPOD PITCHED LANTERN ROOFS

Skypod in Anthracite Grey and White interior

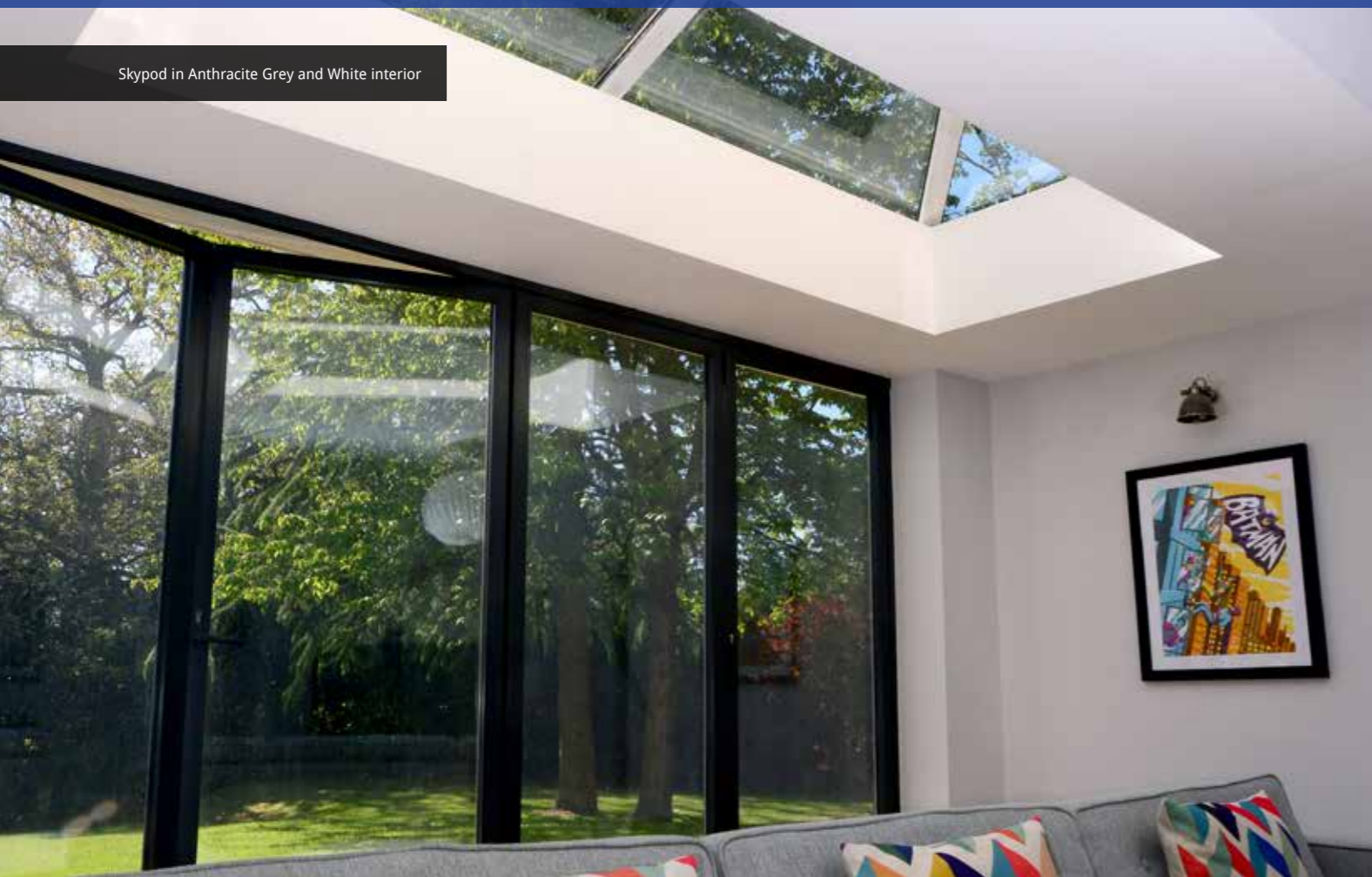

Impress customers and end-users with desirable, space-enhancing lantern roofs

The Skypod pitched lantern roof system enables you to create an eye-catching, contemporary feature that floods the interior of a property with natural light. It brings life and freshness to uninspiring flat-roofed buildings, and makes a stunning alternative to conventional conservatory roofs.

Skypod lantern roofs add height, light and volume to any living space. They are the perfect choice for a wide range of refurbishment, extension or new-build projects – including reception areas, classrooms, orangeries, kitchen-diners and garage conversions.

The perfect alternative to aluminium

Skypod has been designed as an affordable alternative to aluminium skylights, making it accessible for more applications, to more people. As well as value issues, the 'industrial' aesthetic of aluminium skylights is unsuited to many properties and not to everyone's taste.

The architectural design means there are no fussy ridge crestings or finials to fit, giving your customers the ultimate in clean sight-lines. A unique ridge end cover cap completes the sleek appearance.



Designed for superior performance



Fast, accurate installation



U-values as low as 1.0*



20° fixed pitch

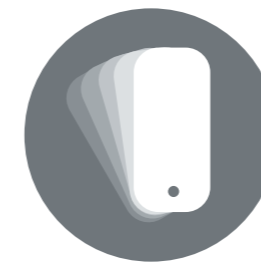

A choice of frame and glass colours



Cheaper than full aluminium alternatives



Kits delivered in 4 working days



10-year guarantee

Energy efficient

Skypod offers significant energy-efficiency improvements, with a U-value as low as 1.0* – helping your customers to save on their energy bills. The PVC-U cappings also help homeowners to match the appearance of their lantern roof to existing PVC-U windows and doors.

Create lantern roofs of any size, up to 2.75m x 8.7m

Skypod is available in a wide range of sizes, so you can create a lantern roof that's suitable for any project. With ten design options to choose from you can tailor Skypod to suit your customers' individual needs.

Simple, fast installation – for a quality-assured finish on every job

Crucially, Skypod has been designed for fast, accurate, simple installation. It requires only square cuts, with no mitring or awkward angles to negotiate, and all screw holes are pre-drilled. This enables installers to give customers a precision-fitted watertight lantern roof, while making the job as quick and easy as possible.

Delivered in four working days

Once the site has been surveyed and measurements taken, you can order your bespoke Skypod roof from Deeplas. Your complete ready-to-install kit, including all screws and fixings, will be delivered in 4 working days.

MORE FLEXIBILITY

ROOF STYLES TO SUIT YOUR STYLE



Now you can give your customers a square lantern roof – with symmetrical looks!

No side rafter bars

With the fewest possible number of slimline bars needed to create uninterrupted glazed surfaces of up to 1.5m x 2.75m, Skypod with no side rafter bars is the cleanest, simplest way to introduce overhead natural light into any room space. It offers a practically unobstructed window on the world above and, come rain or shine, keeps homeowners warm and comfortable thanks to its temperature controlling glass and high levels of energy efficiency.

With side rafter bars

By introducing additional bars to the standard Skypod design, side rafter bars extend the possibilities for fully glazed rooflights to spans of up to 1.5m wide x 7.45m long. The result is a dazzling feature roof that turns what could so easily be an underwhelming flat roof extension into a year round living space with all the natural light and lofted headroom your customers could ever wish for.



Skypod with no side rafter bars

Three-bar ridge end

The extra strength and rigidity of our 3-bar Skypod option not only allows you to install even longer, even wider vaulted rooflights into your customers' homes. It also gives a much more traditional 'orangery' style look to their rooflight, with the introduction of classically proportioned end panels in a spacious vaulted glass ceiling up 2.75m wide x 8.7m long in size.

Skypod square

The alternative to a single span rectangular rooflight, our square lantern roof offers perfectly balanced sightlines and, thanks to its simple 4-hip design, higher levels of natural light than conventional designs of the same surface area. Because it can be produced in sizes right down to 0.5m x 0.5m, it means even the smallest flat roofed space in the home can benefit from day long natural light.



With this 3-bar ridge end design, you can create larger lantern roofs

SKYPOD PLUS

THE ALUMINIUM SKYPOD

Skypod Plus in Matt Black



Skypod Plus in Matt Black

The contemporary and balanced aesthetics on Skypod Plus have been achieved by avoiding the use of bulky end caps, crestings and finials, which are incorporated into skylights when using standard conservatory components.

Skypod Plus is available in two formats: kits from our kitting department and individual bar length components.

Architectural aesthetics with added protection against the elements

Building on the existing purpose designed thermally broken aluminium ridge and ring beam, Skypod Plus now offers aluminium rafter top caps. This means the whole of the external face not only offers stunning architectural aesthetics but also greater protection against the harsh summer midday sun. All internal bars are capped in the conventional way with PVC-U and are available in a black, white or grey finish.*

Skypod Plus is available in 2, 3 bar options and the square shape and is available in black, white and grey. The system has a fixed roof pitch of 20° and is supplied in a choice of five self-cleaning, temperature controlling glass options, with a centre pane U-value of 1.0W/m²K achievable.**

* Black and grey internal finishes are produced by a spraying process.
** Centre Pane U-Value. Standard U Value is 1.2 centre pane. U-value is applicable to glass only.

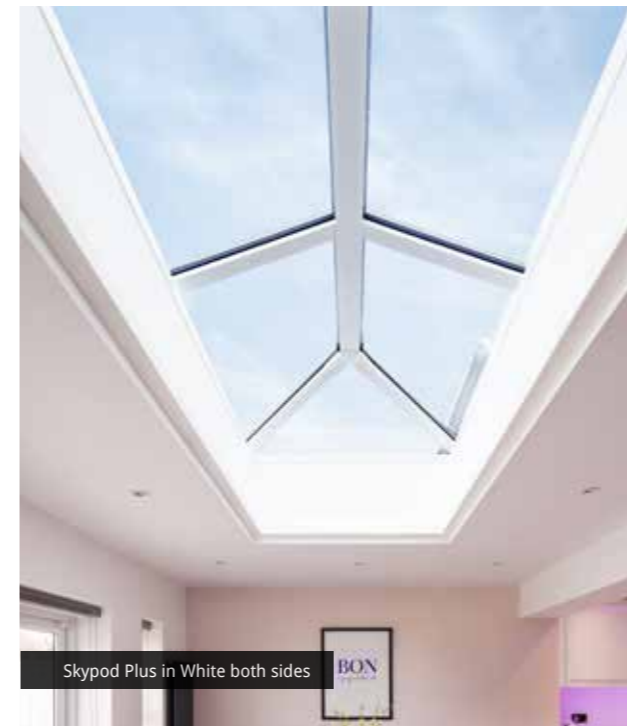

Skypod Plus in White both sides



Skypod Plus in Grey both sides

EXCEPTIONAL STYLE & PERFORMANCE

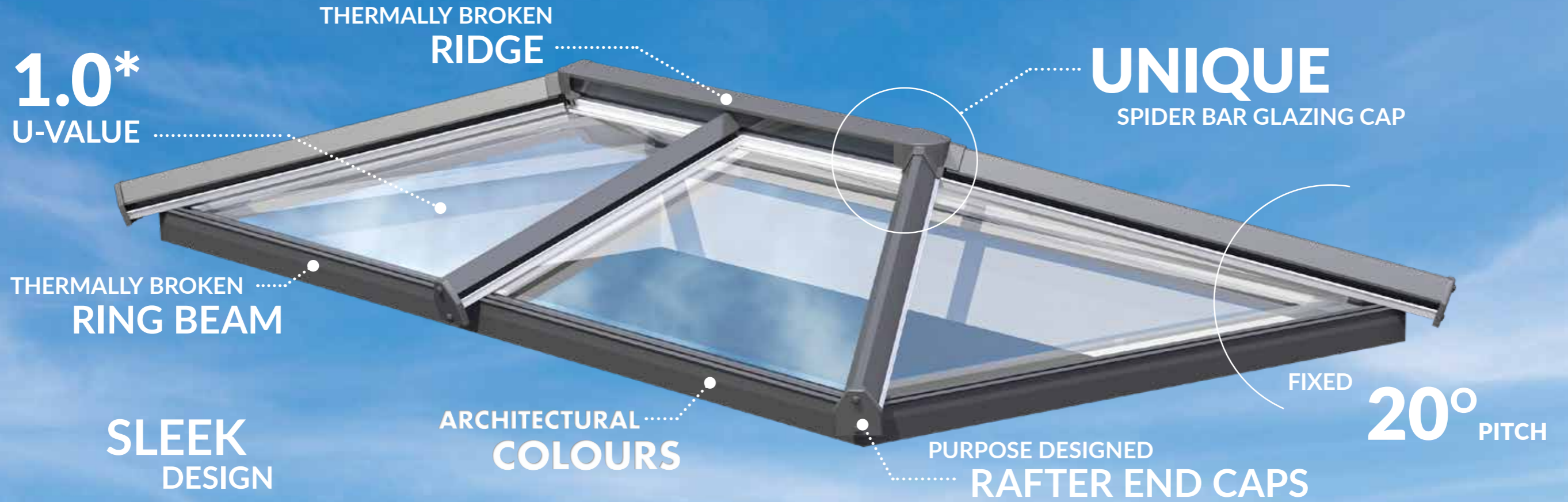

New and improved

The Skypod pitched lantern roof system has had further enhancements with the introduction of a more discreet internal boss, purpose designed and secure fix external rafter end caps and a thermally broken ring beam to create a virtually condensation free finish.

Colours to frame the view

Skypod has a white internal finish as standard, to maintain a bright, fresh interior. A range of external colours are available to complement existing architectural style, as well as a choice of glass options. Skypod Plus has a white internal finish, or an option of black or grey finish*.

Ten-year guarantee

Skypod lantern roofs are guaranteed for ten years. That means you can give your customers the assurance of a robust, well-designed, precision-made product that's built to last.

SKYPOD FRAME COLOURS



SKYPOD PLUS FRAME COLOURS



GLASS COLOURS

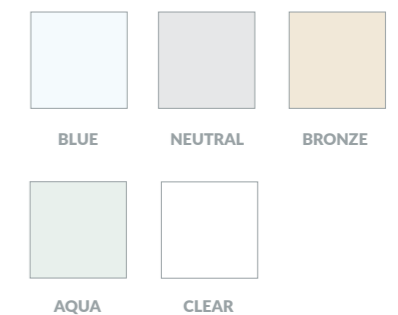

ADDITIONAL COLOURS AND SPECIFICATIONS ARE MADE TO ORDER ON EXTENDED LEAD TIMES

* Black and grey internal finishes on Skypod Plus are produced by a spraying process

TECHNICAL INFORMATION

MINIMUM AND MAXIMUM SIZES

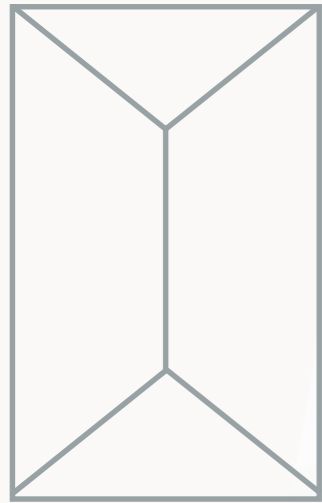

No 'side-bars' needed on sizes up to 1.5m x 2.75m

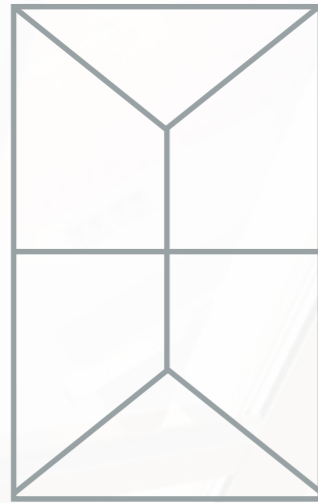

Up to 1.5m x 7.45m



Up to 2.75m x 8.7m



Up to 2.75m x 2.75m

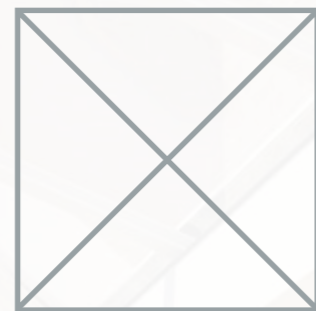

Up to 1.5m x 1.5m

Note: Design will vary dependent on size. All Skypod lantern roofs are made-to-order, and you will receive a design to sign-off before the item goes into production.



equinox® | SOLID TILED ROOFS

**EQUINOX JUST GOT EVEN BETTER
THE DIFFERENCE IS NIGHT AND DAY**



To meet the evolving needs of the trade and homeowners, we have made further improvements to our Equinox Solid Tiled Roof.

The new 25° fixed angle soffit ring beam option allows for a traditional overhang soffit. Plus, the additional soffit surface area provides the option to be specified with external downlighters.

The lights can be installed as either a cool or warm white and can be specified with a twilight sensor, turning the lights on automatically as natural light fades.

What's more, Equinox is now available with Envirotile!

If you are interested in fabricating our products, please call us on

0800 988 7307

or visit deeplas.co.uk



LUMA ROOFLIGHT

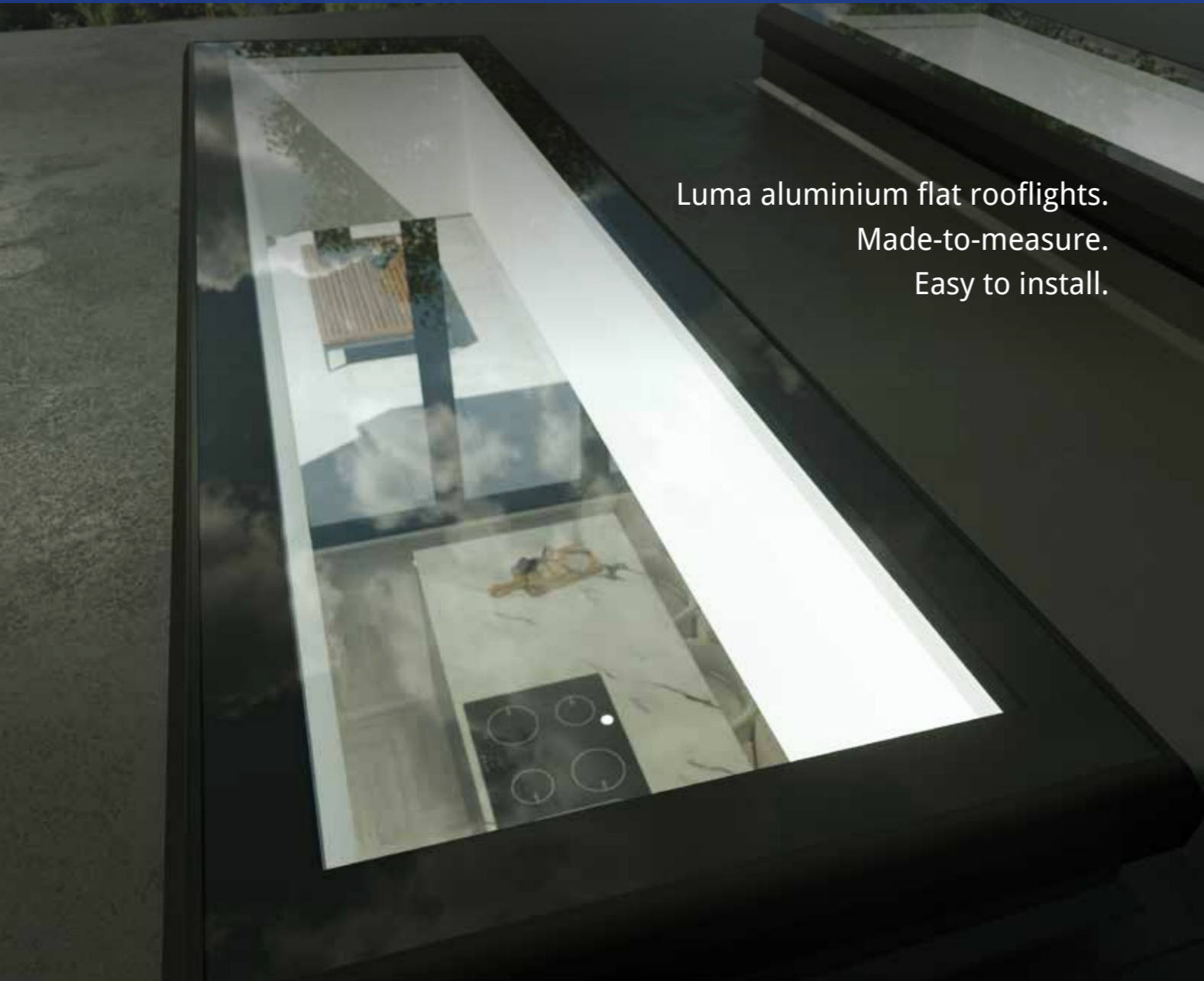

Luma aluminium flat rooflights.
Made-to-measure.
Easy to install.



Transforming rooms into vibrant living spaces

It's no secret that exposure to natural light can do wonders for your physical and mental health. Daylight lifts your mood, makes you feel motivated, improves your productivity and helps you to sleep better. So, with all those benefits, doesn't it make sense to bring more daylight into your home? With Luma flat rooflights, you can.

Luma flat rooflights are elevated, fixed shut, flat roof windows with a sleek and contemporary look.

And, unlike roof lanterns, there are no bars across the glass to interrupt your view of the sky or cast shadows across your room.

They're the perfect way to flood your home with natural light.

So, whether you're planning a new flat roof extension or want to breathe life into an existing one, adding Luma flat rooflights will totally transform the space.



Better by design

We believe you should never have to compromise on quality or performance when you make improvements to your home. That's why innovation is at the heart of our Luma flat rooflights. We've built-in exclusive, market-leading features that come as standard to bring you a premium-quality product that performs excellently.

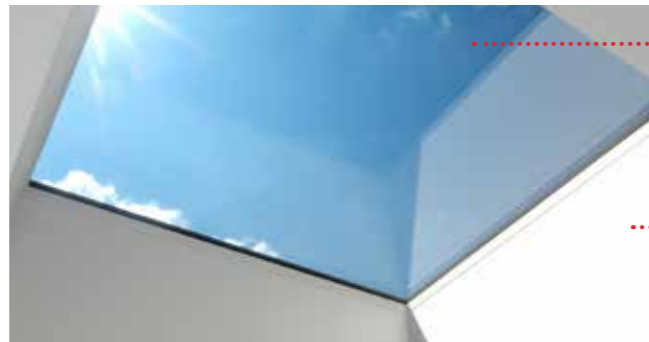

Thermally broken and glazing options for excellent energy efficiency

Luma's aluminium frame has an integrated thermal break, which reduces heat transfer. And it's available in double-glazed and triple-glazed options, with U-values of 1.3 W/m²K for double and 0.92 W/m²K for triple-glazed. So, you'll stay cool in summer and warm in winter and save money on energy bills.

Tinted laminated glass options

Luma is available with either neutral or blue tinted glass. Tinted glass still allows the light to flood in but reduces uncomfortable glare when the sun hits the glass.

Secured from the inside

Exclusive to Luma

The only flat rooflight which is fixed from the inside for added security.

Slimline modern profile with sleek seamless glazing

Exclusive to Luma

Luma's sleek aluminium frame and unique glazing tape mean there are no chunky frames or painted borders. And there are no bars across the glass to impede your view either. The inside is beautifully finished with a PVC plasterboard trim. The result is minimal framework and maximum daylight.

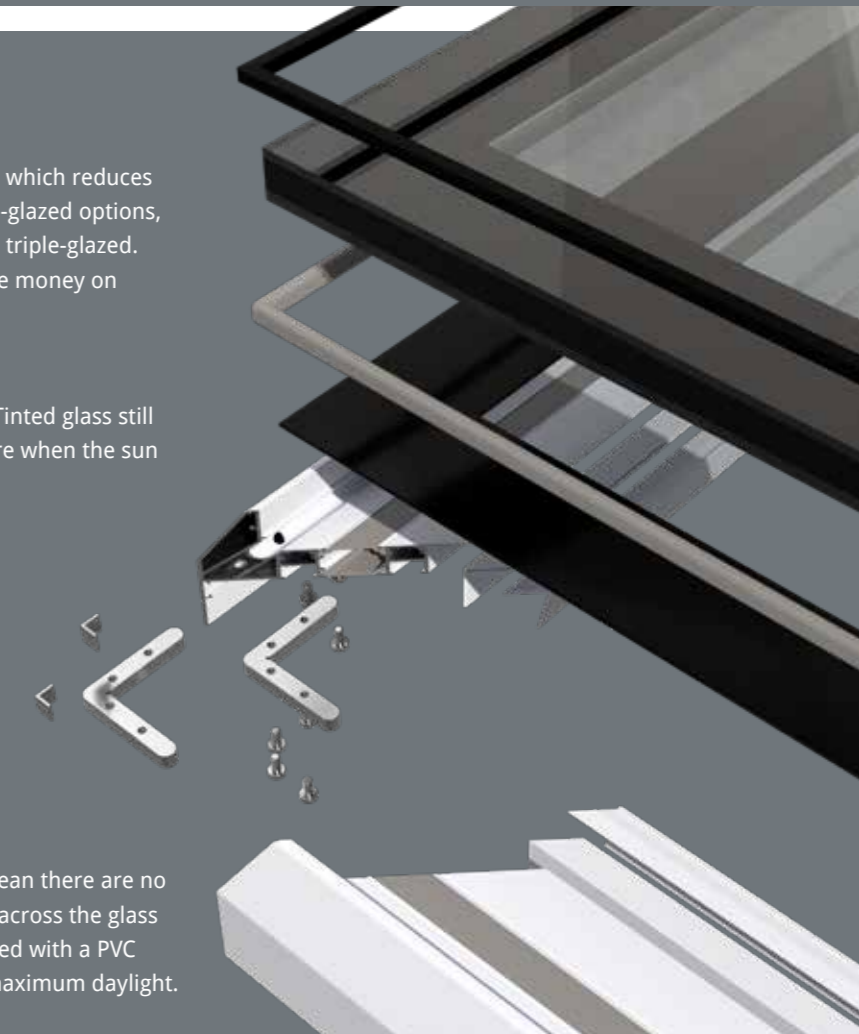

Integral drainage system

Exclusive to Luma

The outer frame includes a unique drainage system that allows moisture to drain away outside for added reassurance.



High performance self-cleaning glass

Luma features self-cleaning glass. It has a special coating that uses UV rays to break down organic matter on the surface, which then washes away when it rains. So, the glass stays cleaner for longer, and the need for regular washing is significantly reduced.

Available in square and rectangular designs

Luma flat rooflights are made to measure, allowing you to create a rooflight that perfectly fits your space and style.

Square designs range from 500 x 500mm to 1400 x 1400mm, and rectangular designs from 500mm wide up to 3000mm projection.¹ Add just one rooflight, or consider adding two or more for a large extension.

Luma flat rooflights are suitable for many projects, such as existing or new flat roof extensions, garage conversions, new builds and even garden rooms.

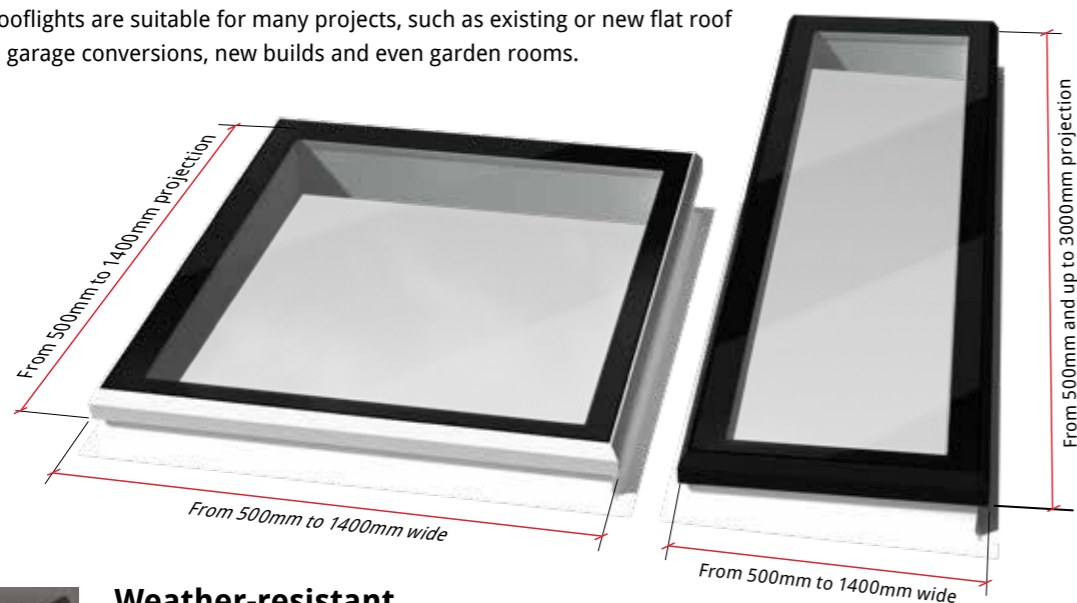

Weather-resistant powder-coated frame

Luma is built to withstand everything the British weather can throw at it. Its aluminium frame is powder coated for durability and has a UV-resistant, weather-tight seal. It also comes in a choice of finishes to complement your home. Opt for a standard black or white frame or choose from a range of painted colour options.²

Frame colours



Glass options



Luma flat rooflights at a glance



Rigid slimline aluminium profile
The visible framework is minimised, and daylight is maximised.



Secured from the inside
Fixed from the inside for added security.



Double or Triple glazed options
Laminated high performance self-cleaning glass.



Excellent energy efficiency
Thermally broken frame and U-values as low as 0.9.³



10-year guarantee
For peace of mind.

1. Subject to maximum glass area of 2.5m² (double-glazed) / 2m² (triple-glazed). May also be subject to Eurocell's handling restrictions.
2. Extended lead times apply.

3. U-values of 1.3 W/m²K for double and 0.92 W/m²K for triple-glazed.
4. Installation at 5° pitch is recommended.
5. Applies within normal office working hours: Mon-Fri 8.30 - 17.00.

ARE YOU AN INSTALLER?



Future Homes Ready

Building Regulations are changing.

In 2025 a new Future Homes Standard will be introduced, which requires all new homes to be future-proofed with low-carbon heating and world-leading levels of energy efficiency.

So, we've designed Luma flat rooflights to be Building Regulations compliant.

Not just for now but for the future too.

Easy to install and delivered straight to site

Luma flat rooflights are made to order in our factory, then delivered straight to site. They're easy to install, helping you complete the job quickly, with no fuss and no mess.



2-5° installation pitch

Flexible installation options to minimise pooling of water.⁴

Our service promise to you

We know how important it is to you to keep your customers happy. That's why we take great pride in consistently providing a friendly, approachable service to make finding and getting what you and your customers need quick and easy.

Here's how we help:



Quotes in under 1 hour

There's no waiting around. Just call, drop us an email or fill in the contact form on our website to request a quote, and we'll respond within an hour.⁵



Lead times to suit you

Tell us when you need the products to be on site, and we'll ensure they're there at the right time.



Order checking

Our orders are thoroughly checked prior to delivery, allowing you to get on with installing Luma right away.



Technical support line

Luma flat rooflights are easy to install, but if you need help, our expert technical team are just a phone call away.

EQUINOX - SOLID TILED ROOF

WHY CHOOSE EQUINOX?

TRANSFORM YOUR CUSTOMERS' UNDER-USED CONSERVATORIES INTO FUNCTIONAL LIVING SPACES – 24/7, 365 DAYS A YEAR



Innovative design features, even more options and enhanced benefits – Equinox is the market-leading tiled roof system

While homeowners love the extra space and light that a conservatory brings, changing temperatures can make them uncomfortable to use – too hot in summer and too cold in the winter months.

With the Equinox product, you can offer your customers the perfect solution. This market-leading tiled roof system means that you can add a valuable extra space to their home without the high cost of building an extension. There's rapid, no-hassle fitting too, making Equinox your natural choice.

Superb looks and outstanding energy efficiency too

As well as offering more fascia colour options than alternative tiled roof systems, Equinox allows your customers to choose between a realistic slate-effect or steel tile finishes. A selection of roof window or fully glazed panel options also means that customers can enjoy plenty of natural light in their living space. It all adds up to a higher value sale for you.

Of course, customers also have one eye on their heating bills – so they demand excellent energy efficiency. Equinox has that covered, with an exceptional U-values as low as 0.15 possible.



Variable or fixed pitch options and a soffit ring beam

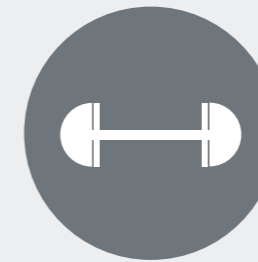

Greater structural strength



Easy and quick installation in 2 days*



Better value than ever



Design-engineered for outstanding technical performance



U-values as low as 0.15



5° pitch for lean-to's

Straightforward and rapid installation for great results every time

You want to save money by minimising the time you spend on site. Your customers want the least disruption and inconvenience possible. Equinox delivers a win-win.

A range of innovative features includes fewer components and pre-positioned ring beam nuts and bolts. Then there's SlateSkin – a unique sheet tile solution so that tiles don't need to be fitted individually – and all of that means faster installation. In fact, you can fit the whole roof in as little as 48 hours* – saving up to a day compared to other systems. What's more, it's watertight the same day so can be safely left overnight.

Reduced environmental impact

When paired with our sustainable roof tile, Envirotile, we are able to reduce the environmental impact we create by having a tile that is made in the UK from 75% recycled content and is Greenspec endorsed.

* water tight on day 1 - full internal fit out can take 4-6 days.
† 5° pitch only available with SlateSkin tile system

Intelligent design for a wide range of roof options

Because Equinox offers variable pitches between 5-35°, you can gain more customers by offering a wider range of roof options – including lean-to's, previously unavailable to tiled roofs. We now also offer fixed pitch aluminium options for 15° & 25° making for a simpler roof, which will cater for over 60% of designs.

A reduced ring beam overhang means that there are no problems with conservatories on boundary lines – and no loss of strength. There are no load-bearing issues either, thanks to its internal roof support structure system, so Equinox is fully compliant with Building Regulations Part L.

And now you can match existing homeowners' properties with our soffit ring beam clad in our traditional foamboard roofline and guttering in a range of colours while providing the option to highlight the conservatory with our external grade downlighters.

BETTER VALUE THAN EVER



Edwardian Equinox with Composite Slate tiles in Pewter Grey



Edwardian Equinox Vega



Gable Ended Equinox Vega with Composite Slate tiles in Pewter Grey

Advanced features deliver even better performance and higher quality

Featuring purpose-designed components including flush fitting rafters and a variable ring beam, Equinox brings your customers real confidence and peace of mind. They'll know that they have chosen a premium quality product. They'll certainly appreciate the great looks too, with a traditional plastered internal finish and a wide choice of colours across our four tile style options including the eco-friendly Envirotile system, slate style tiles and standard steel tiles.

Outstanding versatility for a range of living spaces

Equinox isn't just a great system for conservatory roofs. This versatile solution can also be used to transform flat roofs – whether on a new extension or an existing flat roof that's ready for a change. In fact, no job's too small for Equinox. Even porches can benefit from a contemporary makeover.

Delivered in 5 working days

Once the site has been surveyed and measurements taken, you can order your bespoke Equinox roof from Deeplas. Your complete ready-to-install kit, including screws and fixings, will be delivered with flexibility to suit you in 5-7 working days. You can then either collect it yourself or arrange for free delivery direct to your site.

equinox^{VEGA}

LET'S MORE NATURAL LIGHT IN

Innovation that opens up even more opportunity

Natural light is a welcome guest in every home. So our engineers have developed an innovative way for homeowners to invite the maximum light levels in. Equinox Vega takes the system to a whole new level in terms of size, strength, efficiency and illumination.

More light

Equinox Vega features large glazed areas of up to 1000mm wide providing up to 850mm widths of visible natural light for brighter, sunlit conservatories that give an impression of even more space.



Gable Ended Equinox Vega interior



Gable Ended Equinox Vega interior

Edwardian Equinox with Envirotile Slate tiles & Soffit Eaves with downlighters



equinox[®]

THE DIFFERENCE IS NIGHT & DAY

The sustainable choice

Our market-leading Equinox warm roof solid tiled solution is now also the sustainable choice. Paired with Envirotile, our precision manufactured recycled polymer tile system with excellent green credentials you have a solution with reduced environmental impact. The lightweight composition and interlocking fixing system means it quicker and easier to install too.

Improved ventilation

Aluminium rafters in the lightweight roof have been separated from the 18mm OSB timber deck to increase the air gap, providing a clean flow of air through the roof system. The enhanced ventilation of our system allows the roof to breathe adequately reducing the risk of any condensation.

Energy efficiency

New high performance styrene helps boost overall roof energy efficiency and thermal insulation to keep the room below comfortable enough to use at any time of the year.

Structural strength

Upgraded boarding in the roof system sandwich increases overall strength to allow larger areas without risk of sagging.

Light up your world

The new 25° fixed angle soffit ring beam option allows for a traditional overhang soffit appearance to match homeowners' properties for a seamless integration. Furthermore, the additional soffit surface area provides the option to be specified with external downlighters. The lights can be installed as either a cool or warm white and can be specified with a twilight sensor, turning the lights on automatically as natural light fades.



SAVE TIME

- ▶ **Quicker & easier installation**
Easy and quick installation in just 2 days.
- ▶ **Quotes & amends in under an hour**
We aim to get quotes and amends back to you in within the hour.
- ▶ **Flexible lead times to suit you**
Tell us when you need it and it will be there. Average delivery time of under 5 days.



SAVE HASSLE

- ▶ **On-site support for peace of mind**
Our qualified engineers can assist with surveys and on-site installation training.
- ▶ **Leading technical support**
A dedicated support network to assist you throughout the process.
- ▶ **Roofs delivered on time in full**
Last year over 99% of our roofs were delivered on time in full to our customers.



Edwardian Equinox with Envirotile Slate tiles & Soffit Eaves

HOW EQUINOX IS BETTER



New 15° and 25° fixed pitch options allow for simpler roof designs (Variable 5°-35° pitch shown)



Variable and fixed pitch wall plate assembly options offers flexibility



Box gutter assembly designed for easier installation, better looks and improved performance



Fully ventilated roof system now with extra rigidity



Structural Support mullions capable of holding the full weight of an Equinox roof system, where frames are not adequately reinforced

HASSLE FREE ROOF TILING

envirotile[®]

The biggest, lightest roof tiles on the market that lock together in a revolutionary way makes for a quick and easy job for you.

The wider tile design means fewer to fit, giving you time back in your day.

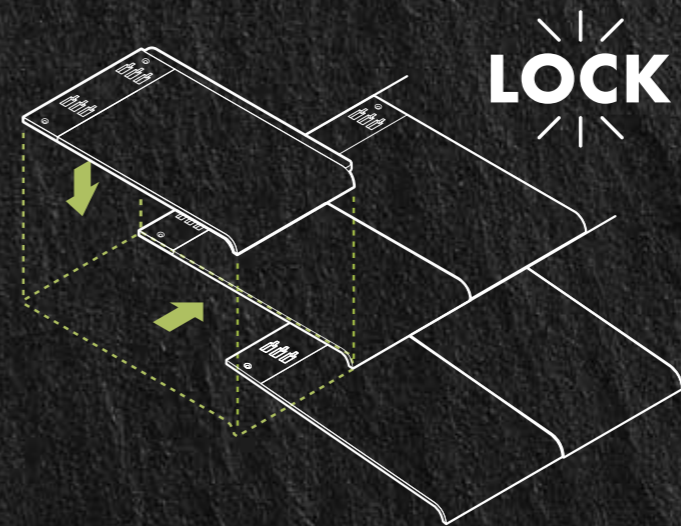

Perfectly positioned every time

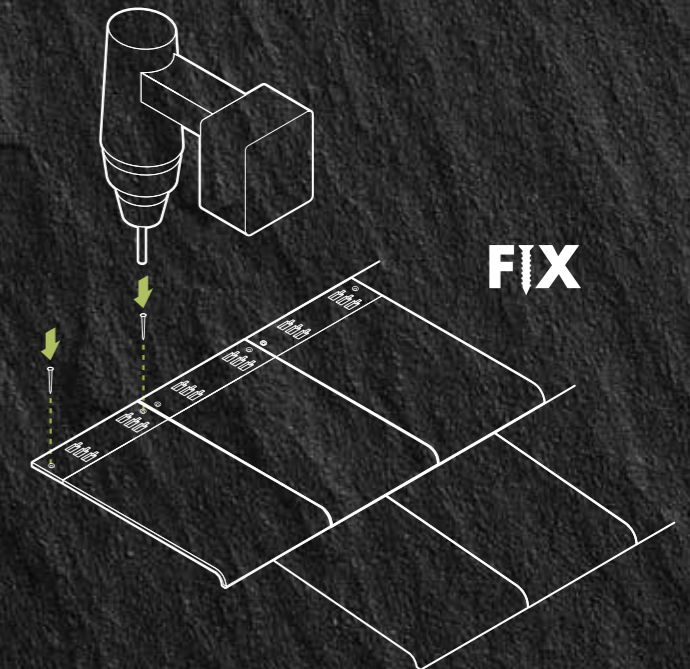

Simply secure with a screw



Lightweight and easy to install



Made from 75% recycled materials



40 year guarantee for peace of mind



Weather tested to 147mph

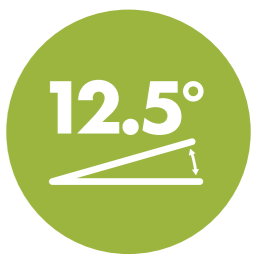

Can be installed to a minimum 12.5° pitch

INSTALLATION

HAS NEVER BEEN SIMPLER

As the UK's market-leading manufacturer of PVC-U profiles, we understand that to remain competitive installers need high-quality products designed for simple, fast and accurate fitting.

We know that if you can quickly and repeatedly complete jobs to a high standard, you will keep your costs down, improve your profit margins and keep your customers happy. You'll also have fewer rectification call-outs once the job is finished.

Equinox boasts a host of advanced features to make installation faster and more straightforward than ever before. That means saved time and money for you – and minimal disruption for your customers. Here are just a few of the built-in benefits for installers:

Fewer components for faster fitting

All ring beam nuts and bolts are already positioned, so there's less preparation needed.

Better, more flexible components

Adjustable angles on the hip, valley and ridge add up to easier fitting, as well as making sure that tiles and ridges sit correctly for finishing. All rafters sit flush with any hips and valleys too, providing greater strength.

Get the job done – quickly

Equinox tiled roofs can be installed in just two days, and are watertight on day one, with a three-man installation team.



MULTI-LAYERED ROOF DESIGN

OFFERS SIGNIFICANT PERFORMANCE BENEFITS



Bringing technological innovations to the forefront of roof design, you can be sure that your customers will enjoy years of outstanding performance from their Equinox tiled roof.

Improved performance

Your customers can look forward to reduced noise and glare too, plus exceptional energy saving performance to help them save money on their heating bills.

FULL GLAZING PANEL & ROOF WINDOW OPTIONS NOW AVAILABLE



CHOICE OF TILES & COLOURS

Now includes Envirotile in a choice of four colours

MULTI-LAYERED ROOF DESIGN

0.15* U-VALUE

FIXED PITCH 15° & 25°

Fixed 25° Soffit eave option now available

OR

VARIABLE PITCH 5-35°

FULLY VENTILATED ROOF SYSTEM

equinox®

STYLE & COLOUR OPTIONS

Colours to frame the view

Like all our PVC-U products, Equinox is precisely colour-matched to all our window, door and conservatory roof products, creating a co-ordinated, consistent look across any property.

10-year guarantee

Equinox roofs are guaranteed for ten years*, so you can give your customers the assurance of a robust, well-designed, precision-made product that's built to last – manufactured by the UK's leading PVC-U specialist.

SlateSkin GRP sheet tiles offer a 25-year product guarantee*. Steel tiles offer a guarantee of 40-years* and composite slate tiles carry BBA certification and a guarantee of 40-years*.

Our new Envirotile lightweight sustainable tile comes with a 25-year guarantee* and is responsibly sourced and made from recyclable content.

FASCIA COLOURS

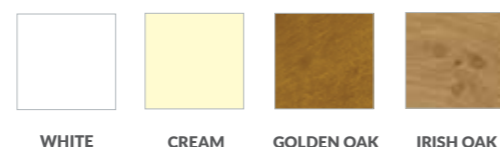

Additional colours are made-to-order on extended lead times

GUTTERING COLOURS

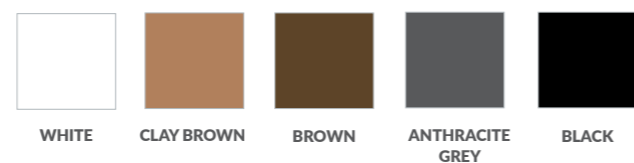

STEEL TILES

High-quality steel tiles come as standard, and are made from lightweight steel in a choice of colours.



COMPOSITE SLATE TILES

Made from a recyclable mix of limestone and polypropylene, composite tiles offer traditional looks without risk of shattering, fading, warping or cracking.



envirotile®

Smart sustainable roofing solutions that protect homes and the planet

ENVIROTILE SLATE

Recycled polymer lightweight roof tile with an interlocking system that makes your job easier.

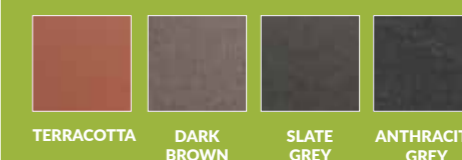

SLATESKIN GRP SHEET TILES

The GRP sheet roof tile system that gives a traditional slate-effect in half the time



For advice on cutting and grinding of SlateSkin please refer to the Equinox Installation Guide or visit www.hse.gov.uk/plastics/faqs.html

Please note: All our SlateSkin kits come with pre-cut ready to fit sheets.

STYLES TO SUIT EVERY PROPERTY

SUITABLE FOR ALL CONSERVATORY ROOF TYPES



VICTORIAN



EDWARDIAN



GABLE-ENDED



LEAN-TO



P-SHAPED

PLUS!

Equinox is also suitable for:

- ▶ Extensions
- ▶ Porches



Bespoke combination Equinox with Composite Slate tiles in Pewter Grey

ROOF WINDOWS



Optional pivot roof windows – available in manual and electric options – allow you to create bright and airy spaces, flooded with natural light. The Equinox Vega glazing solution allows even more natural light.

INTERNAL FINISHING



You could even incorporate surface mounted or fire rated downlights when finishing the job internally for a premium finish. We can supply the correctly specified downlights with all Equinox roof kits.

Whether you're a bar length or kit customer, we can now supply you with all the plasterboard you need to finish a job.

TECHNICAL INFORMATION

ROOF CROSS SECTION

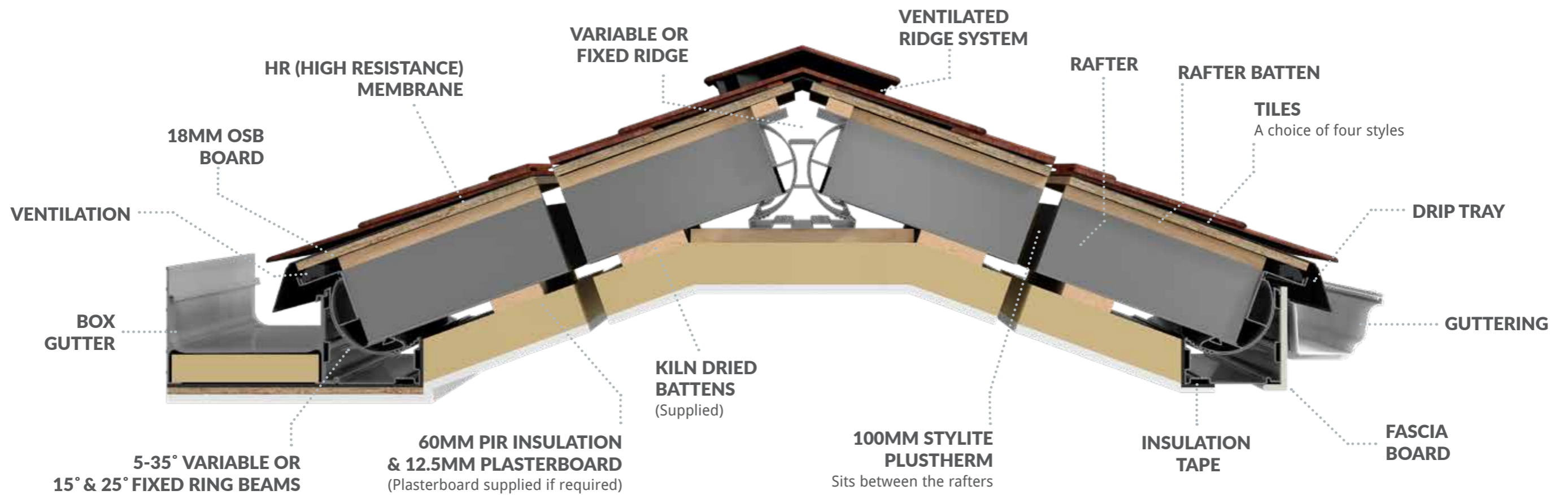

COMPARISON CHART

BENEFIT	EQUINOX	OTHER ALUMINIUM SYSTEMS	CLADOVERS
STROMA BUILDING CONTROL SYSTEM APPROVAL	YES	NO	NO
ACHIEVABLE 0.15 U VALUE SUPPLIED AS STANDARD, NO MATTER WHERE INSTALLED IN GREAT BRITAIN	YES	NO	NO
SLATESKIN GRP SHEET TILE SYSTEM COMPATIBLE ALLOWING A PITCH AS LOW AS 5° (ON LEAN TO DESIGNS)	YES	NO	NO
SLATESKIN CUT TO SIZE FOR ALL ROOF KITS THAT CUTS TILING TIME DOWN BY UP TO 50%	YES	NO	NO
SOFFIT RING BEAM AND EAVES WHICH CAN BE SUPPLIED WITH VARIABLE CCT DOWNLIGHTERS	YES	SOME	SOME
FULLY VARIABLE PITCH SYSTEM CAPABLE OF HANDLING A RANGE BETWEEN 5° - 35° ON LEAN-TO'S AND 15° - 35° ON RIDGED DESIGNS	YES	NO	NO
FIXED PITCH LEAN-TO'S AT 15° AND RIDGED DESIGNS AT 25° POSSIBLE TO REDUCE COST PRICES OF KITS.	YES	NO	NO
FULLY VENTILATED SYSTEM FROM RING BEAM TO RIDGE / WALLPLATE	YES	SOME	NO
ON SITE ASSISTANCE ON BOTH SURVEYS AND INSTALLATIONS BY OUR TECHNICAL ENGINEERS	YES	SOME	NO
MADE TO MEASURE ROOF KITS SUPPLIED OUT OF THE FACTORY WITH AN ACHIEVABLE 5 DAY LEAD TIME	YES	SOME	NO
SYSTEM DESIGNED FROM THE GROUND UP TO BE PURELY A SOLID ROOF, NOT A MIXTURE OF EXISTING PARTS	YES	SOME	NO
QUOTE TURNAROUND OF LESS THAN 1 HOUR	YES	NO	NO
FULL LENGTH GLASS PANEL OPTION POSSIBLE TO CREATE HYBRID GLASS AND TILED ROOFS	YES	SOME	NO
ALL INTERNAL INSULATION PRODUCTS SUPPLIED WITH ALL ROOF KITS TO GUARANTEE 0.15 U VALUE	YES	SOME	NO
WINDOW SUPPORT MULLIONS CAN BE SUPPLIED TO ENSURE THE SUPPORTING PVC-U FRAMES CAN WITHSTAND THE WEIGHT OF THE ROOF. GREAT FOR RETROFIT NEW ROOFS ONTO EXISTING FRAMES	YES	SOME	NO
4 x ROOF TILE OPTIONS AVAILABLE. (STEEL TILES, COMPOSITE SLATE, ENVIRO TILE & SLATESKIN)	YES	NO	NO

EQUINOX SERVICE SUPPORT



SAVE TIME

- ▶ **Quicker & easier installation**
Easy and quick installation in just 2 days and watertight on day one.
- ▶ **Quotes & amends in under an hour**
We aim to get quotes and amends back to you in under an hour.
- ▶ **Flexible lead times to suit you**
Tell us when you need it and it will be there. Average delivery time of under 5 days.



SAVE HASSLE

- ▶ **On-site support for peace of mind**
Our Qualified Engineers can assist with surveys and on-site installation training.
- ▶ **Leading technical support**
A dedicated support network to assist you throughout the process.
- ▶ **Roofs delivered on time in full**
Last year over 99% of our roofs were delivered on time in full to our customers.

**FULL
PRODUCT
RANGE**



DEEPLAS ROOFLINE



**COASTLINE LIGHTWEIGHT
COMPOSITE CLADDING**



**EQUINOX TILED
ROOF SYSTEM**



SKYPOD LANTERN ROOFS



**TWINSON PREMIUM
CLADDING**



**INTERNAL WALL
& CEILING PANELS**



TWINSON DECKING



**ROOMLINE PVC-U
SKIRTING**



**DEEPLAS EMBOSSED
CLADDING**



**SLATESKIN GRP
SHEET TILE SYSTEM**



**DEEPLAS WINDOW
BOARDS**



RAINWATER



SHOWER PANELS



GARDEN ROOMS

Customer service

If you need any assistance, please call the Customer Services team on **0800 988 7307** or visit **deeplas.co.uk**