

NEW

ICONIQ

A REVOLUTION IN ROOF LANTERNS

OUR SERVICE PROMISE



Customer first

Whatever you need, we're here to help.



Fast quotes

Receive a detailed, personalised fast quote.



Technical support line

Need help? Our expert team is just a call away.



Assisted surveys

Need a site survey? We'll arrange for an engineer to assist.



Order checking

Every order is checked before delivery, so you can get straight to work.



Lead times to suit you

Tell us when you need it and we'll make sure it arrives on time.



Assisted installations

Need installation support? We'll arrange help on-site.



Always a solution

No matter the project, we have a roof lantern to fit.



Customer service

If you need any assistance, please call the Customer Services team on 0800 988 7307 or visit [deeplas.co.uk](https://www.deeplas.co.uk)



ICONIQ ROOF LANTERN

MEET OUR NEW ROOF LANTERN



A revolutionary aluminium roof lantern designed to make your job easier and your work stand out. Made from premium materials and offering the fastest installation time on the market, Iconiq helps you complete projects more quickly.

Built with installers in mind, it's efficient, durable and easy to fit – meaning less time on-site and fewer maintenance issues. A high-quality product all round, Iconiq helps you win more work.

Plus, with its sleek design and exceptional performance, homeowners will love it too.

THE Q-LOK ADVANTAGE

**Less time on-site.
Fewer headaches.
More jobs done.**

The Q-lok system **takes the hard work out of installation.** Fewer fixings. Perfect connections every time. The ring beam, hip beam, ridge beam, and rafters all click together with precision.



INSTALLATION IS EFFORTLESS

Thanks to the Q-lok system you can get it all done in **under 1 hour** and move on to your next job. No on-site drilling or silicone needed

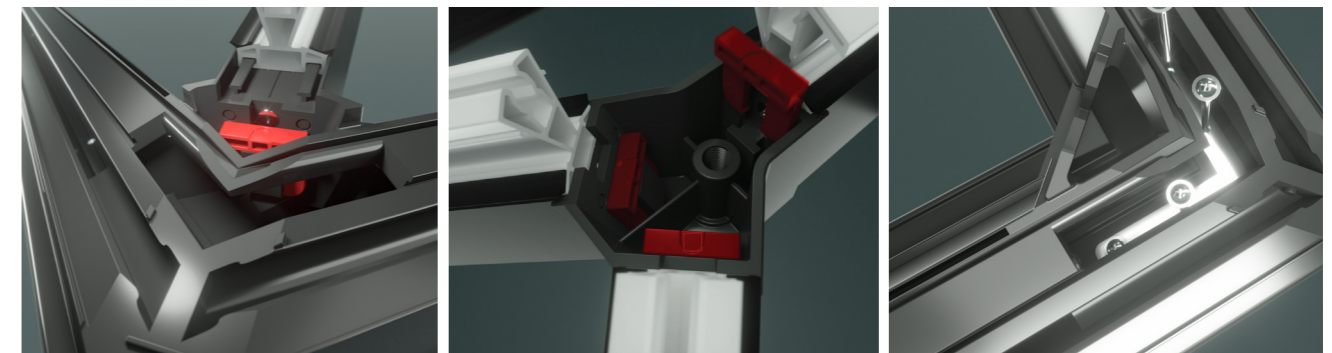

➤ **Rapid-fit slide & lock connections**

➤ **Fit together in seconds**

➤ **Minimal fixings**



Discover more

ICONIQ AT A GLANCE

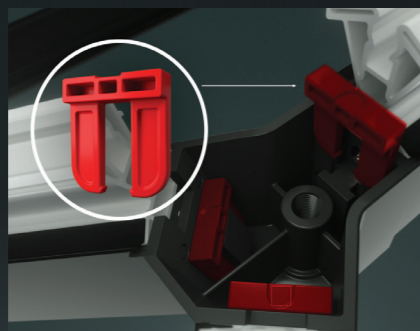

Q-lok technology

Eliminates the need for mechanical fixings.

Made to measure for every project

Custom sizing ensures a perfect fit, with square and rectangular options up to 4m x 9.75m. The largest spanning lantern on the market means you never have to turn down a project.

Largest span

The strongest GRP ring beam on the market gives unmatched strength.



Secure & built to last

Internally fitted glazing clips and interlocking eaves create a strong, secure structure. Anti-tamper screws and tapered frame edges add extra security for your customers' peace of mind.

Fast quotes, short lead times

Fast quotes with lead times tailored to your schedule. Tell us when you need it, and we'll make sure it's ready and on-site.

10-year Guarantee

Built to last and backed by a decade of durability. Sell with confidence, knowing your customers are covered.

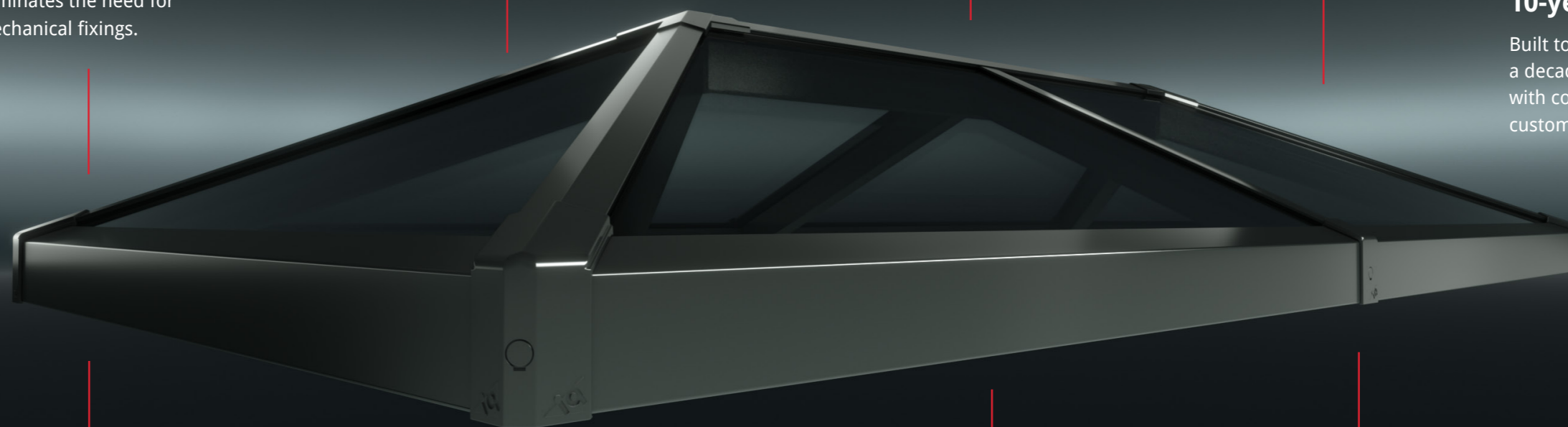

Integral drainage for zero hassle

A unique, purpose-designed system prevents water ingress via the crown moulding, reducing the risk of call-backs.

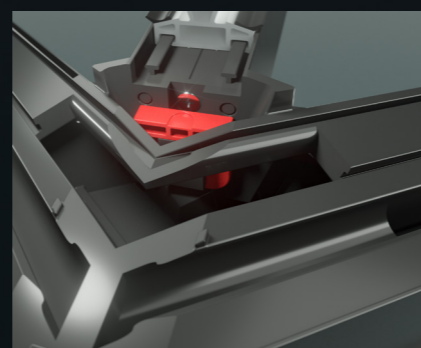

Slide & Lock

Precision connections fit together in minutes.

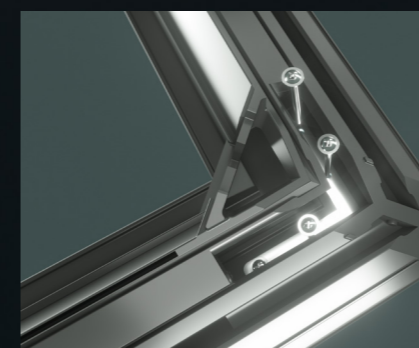

Minimal fixings

Simple installation.

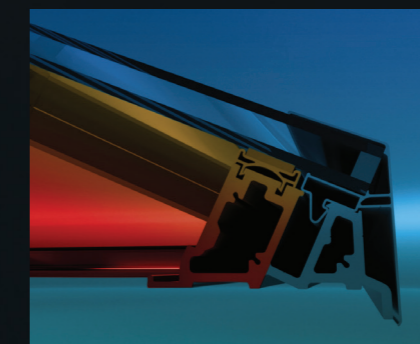

Energy efficient by design

The GRP thermally efficient ring beam and patented Q-lok system create an insulating barrier, making this the most thermally efficient lantern on the market - another great selling point.

ICONIQ ROOF LANTERN

A SPECTRUM OF CHOICE





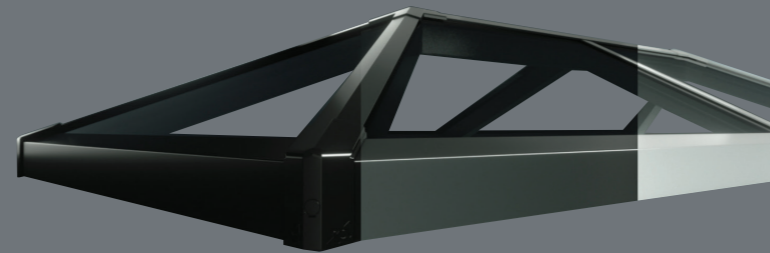

COLOURS FOR EVERY CUSTOMER



Available in Black, Anthracite Grey and White as standard. If your customers want something a little more bespoke, Iconiq can be sprayed with any RAL colour¹ and comes with a range of glass tint options.



FRAME COLOURS

	MATT BLACK RAL 9005		WHITE RAL 9003
	MATT ANTHRACITE GREY RAL 7016		ANY RAL COLOUR SPRAYED ²

GLASS OPTIONS

	CLEAR LAMINATED		BRONZE TINTED		BLUE TINTED
	NEUTRAL TINTED		AQUA TINTED		

¹Additional charge and extended lead times apply.

SPANS THAT DEMAND ATTENTION

The strongest GRP ring beam on the market gives unmatched strength to weight ratio, creating the largest lanterns available on the market. You can take on bigger projects with confidence. More size options mean more opportunities to say yes to jobs, giving you greater flexibility and more satisfied customers.

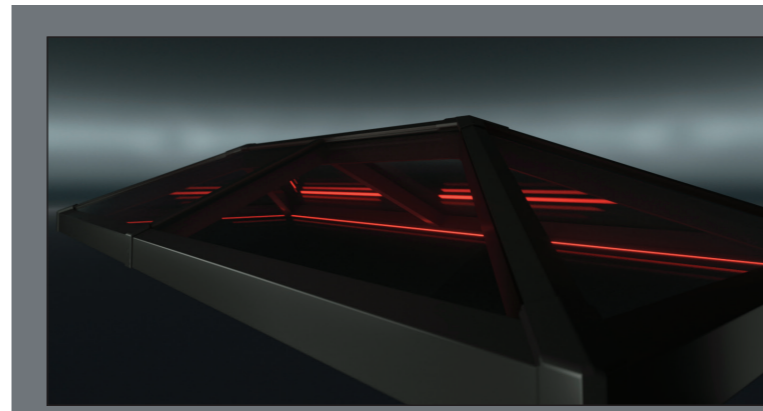
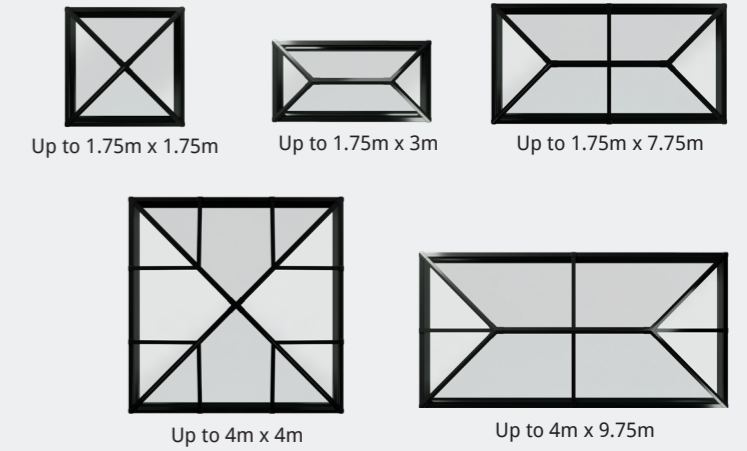

LED LIGHTING

The integrated LED lighting tray allows customers to add lighting to their lantern and create a perfect ambiance throughout the day.²

²Lighting not supplied.

LET THERE BE LIGHT

Iconiq boasts a contemporary streamlined design giving the perfect blend of architectural structure and sky views. A sleek 25° pitch floods spaces with natural light, creating a bright and airy feel your customers will love.



Self-cleaning glass
Whichever glass customers choose, every Aluna Iconiq has a hydrophilic coating as standard so the glass stays clearer for longer.

